



广东惠伦晶体科技股份有限公司  
GUANGDONG FAITH LONG CRYSTAL TECHNOLOGY CO.,LTD.

NO.68 Huangjiang Donghuan Road, Huangjiang Town, Dongguan City, Guangdong Province, China  
TEL :+86(0)769-38879888 Fax :+86(0)769-38879889 E-mail : yl@dgylec.com

# PRODUCT SPECIFICATION SHEET

CUSTOMER : \_\_\_\_\_  
PRODUCT TYPE : SMD X'TAL 2.0\*1.6(4PAD)  
NOMINAL FREQ. : 27.000000 MHz  
FL P/N : 9Y27000002  
REVISION : S0  
CUSTOMER P/N : \_\_\_\_\_

CUSTOMER'S APPROVAL&DATE

--

FL CORPORATION

APPROVED	CHECKED	DESIGNED
Liu Feng	Liao Xiaohua	Li Xiang

MSL1  
RoHS Compliant  
AEC-Q200 Certified



## CONTENTS

## PAGE

• SPECIFICATION REVISION RECORD SHEET	2
• ELECTRICAL SPECIFICATIONS	3
• DIMENSIONS & MARKING	4
• STRUCTURE ILLUSTRATION	5
• RELIABILITY TEST SPECIFICATIONS	6
• PACKAGING REQUIREMENT	7/8
• SPECIFICATION OF THE ENVIRONMENT-RELATED SUBSTANCES	9

## ATTACHMENT ( optional )

- |                                    |   |                              |  |
|------------------------------------|---|------------------------------|--|
| • ELECTRICAL CHARACTERISTICS TEST  | A | <input type="checkbox"/> YES | <input checked="" type="checkbox"/> NO |
| • TEMPERATURE CHARACTERISTICS TEST | B | <input type="checkbox"/> YES | <input checked="" type="checkbox"/> NO |

## Attention

- If you intend to use products on the controlling equipment that relate to medical, aeronautical, aerospace, military science, space and etc, please make sure to let us know your intentions in advance.
- Ultrasonic related process may cause damage to crystal blank by resonance itself. If ultrasonic related process is used, we strongly recommend to assess the damage risk under related ultrasonic conditions before use in production.





## PRODUCT DESCRIPTION

### Standard atmospheric conditions

Unless otherwise specified. The standard range of atmospheric conditions for making measurement and tests are as follow:

Ambient temperature :  $25\pm 2^{\circ}\text{C}$   
Relative humidity 40%~70%

If there is no doubt the results, measurement shall be made within the following limits:

Ambient temperature :  $25\pm 2^{\circ}\text{C}$   
Relative humidity : 40%~70%

### Measure equipment

Electrical characteristics measured by S&A250B or equivalent.

### Crystal cutting type

The crystal is using AT CUT (thickness shear mode)

## ELECTRICAL SPECIFICATIONS

No.	Items	Electrical Spec.				Units	Remarks
		Symbol	Min	Typ	Max		
1	Nominal Frequency	FL	27.000000			MHz	-
2	Oscillation Mode	-	Fundamental			-	-
3	Load Capacitance	CL	6.0			pF	-
4	Frequency Tolerance	-	$\pm 10$			ppm	at $25\pm 2^{\circ}\text{C}$
5	Frequency Stability	-	$\pm 50$			ppm	at $-40\sim +125^{\circ}\text{C}$ (reference $25^{\circ}\text{C}$ )
6	Shunt Capacitance	C0	-	-	3	pF	-
7	Aging (/1 year)	-	$\pm 3$			ppm/year	at $25\pm 2^{\circ}\text{C}$
8	Operating Temperature	-	-40	-	125	$^{\circ}\text{C}$	-
9	Storage Temperature	-	-40	-	125	$^{\circ}\text{C}$	-
10	Equivalent series resistance	ESR	-	-	80	ohms	-
11	Insulation Resistance	IR	500	-	-	M-ohms	at DC 100V
12	ESD	-	HBM > 4000V			-	ANSI/ESDA/JEDEC JS-001
13	MSL	-	Level 1			-	J-STD-020
14	Drive Level	DL	-	-	100	$\mu\text{W}$	-



**DIMENSIONS unit:mm**

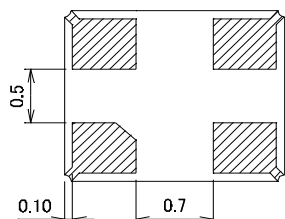
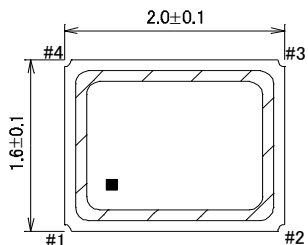

**CONNECTION DIAGRAM (TOP VIEW)**

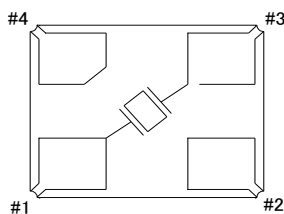

Pin	Function
#1	Xtal terminal (Input)
#2	GND terminal
#3	Xtal terminal (Output)
#4	GND terminal

**LAND PATTERN unit:mm**

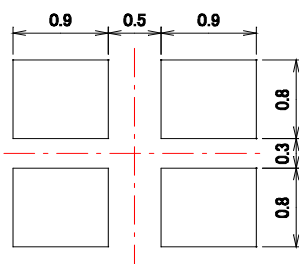

**MARKING**

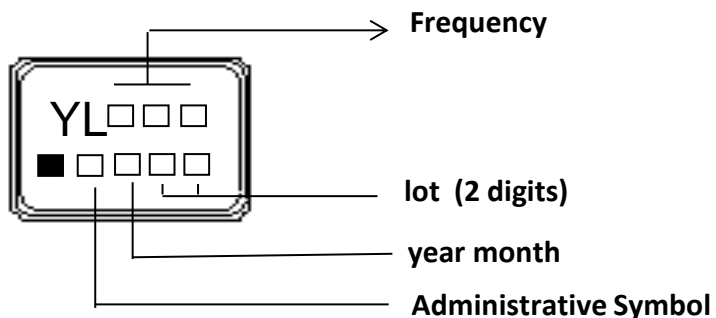

		month											
year		JAN	FEB	MAR	APR	MAY	JUN	JUL	AUG	SEP	OCT	NOV	DEC
2021	2025	A	B	C	D	E	F	G	H	J	K	L	M
2022	2026	N	P	Q	R	S	T	U	V	W	X	Y	Z
2023	2027	a	b	c	d	e	f	g	h	j	k	l	m
2024	2028	n	p	q	r	s	t	u	v	w	x	y	z

**SUGGESTED REFLOW PROFILE**

Total time : 360 sec. Max.  
Solder melting point :225 °C

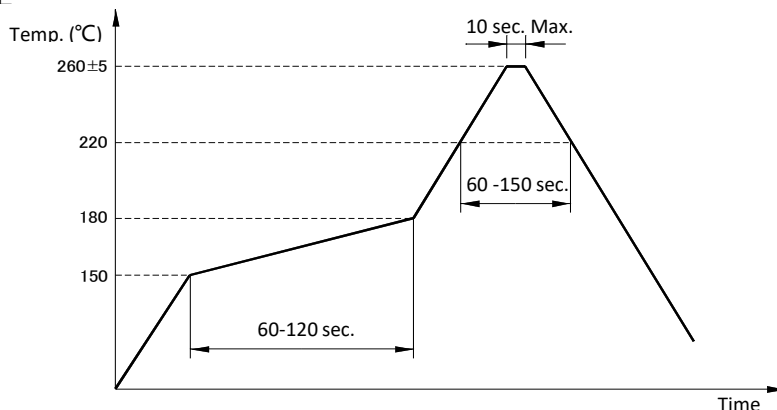



STRUCTURE ILLUSTRATION

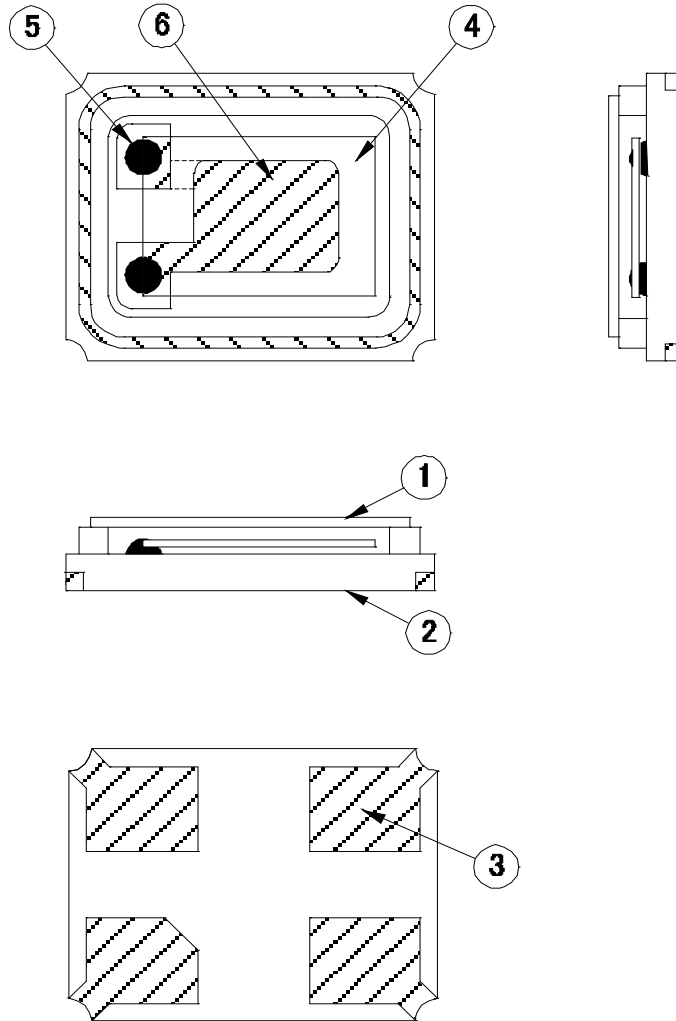

NO	COMPONENTS	MATERIALS	QTY	FINISH/SPECIFICATIONS
1	Cap(Lid)	Kovar(Fe+Co+Ni)	1	Ni plating
2	Base(Package)	Almina Ceramics (Al <sub>2</sub> O <sub>3</sub> )	1	
3	Pad(Package)	Ni + Au	4	Ni+Au plating
4	Crystal blank	SiO <sub>2</sub>	1	-
5	Conductive adhesive	Ag	2	Silicone resin
6	Electrode	Noble metal	2	-



## RELIABILITY SPECIFICATIONS

### 1.ENVIRONMENTAL ENDURANCE (AEC-Q200)

No.	Test Item	Test Methods	
1	High Temperature Exposure	1000 hours at 85°C.	AEC-Q200 TEST 3, MIL-STD-202 Method 108
2	Temp. Cycling	Temperature Cycling 1000 cycles. (-40°C to 125°C for 30 minutes each).	AEC-Q200 TEST 4, JESD22 Method JA-104
3	Biased Humidity	1000 hours at 85°C & 85%RH with V <sub>DD</sub> applied.	AEC-Q200 TEST 7, MIL-STD-202 Method 103
4	Operational Life	1000 hours at 125°C with V <sub>DD</sub> applied.	AEC-Q200 TEST 8, MIL-STD-202 Method 108
5	Resistance to Solvents	3 minutes of immersion and 10 strokes of brush cleaning,for 3 cycles.	AEC-Q200 TEST 12, MIL-STD-202 Method 215
6	Mechanical Shock	100g's,6msec, half-sine,for 3 cycles each in 6 directions	AEC-Q200 TEST 13, MIL-STD-202 Method 213
7	Vibration	10Hz-2000Hz,5g for 20 minutes,12 cycles in each of 3 orientations.	AEC-Q200 TEST 14, MIL-STD-202 Method 204
8	Resistance to Soldering Heat	260°C±5°C,10sec±1sec.	AEC-Q200 TEST 15, MIL-STD-202 Method 210
9	Solderability	260°C±5°C,5sec±1sec, immersing depth:≥0.5mm.	AEC-Q200 TEST 18, J-STD-002
10	Board Flex	Board bending: 2.5mm,bending time: 60s.	AEC-Q200 TEST 21, AEC Q200-005
11	Terminal Strength	Force:1.8kg,force time:60s.	AEC-Q200 TEST 22, AEC Q200-006

\*Storage conditions : 18 months

\*Constant humidity : 40~70%



**PACKING :**

8mm-4mm, 3000pcs / reel,  $\phi 178$ ;

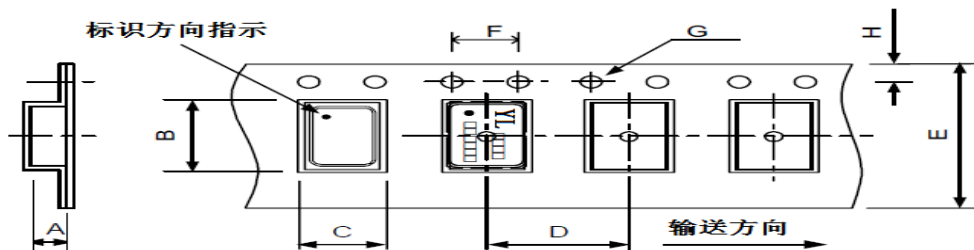

Dimension	A	B	C	D	E	F	G	H	Unit:
	0.65 $\pm 0.1$	2.20 $\pm 0.1$	1.90 $\pm 0.1$	4.00	8.00	4.00	1.50	1.75	mm

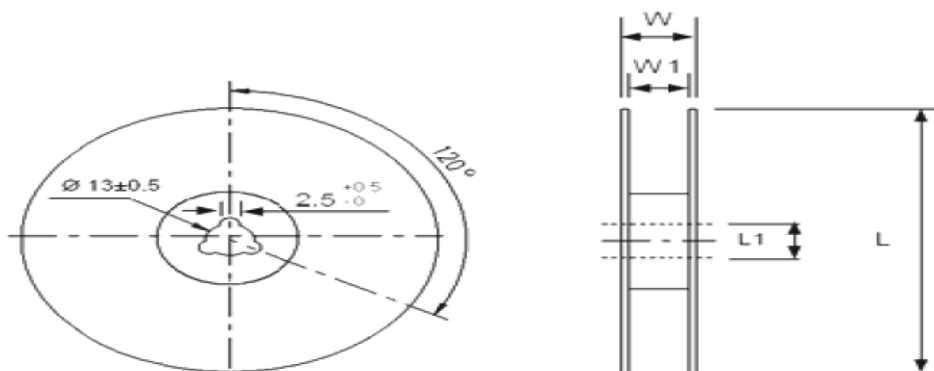
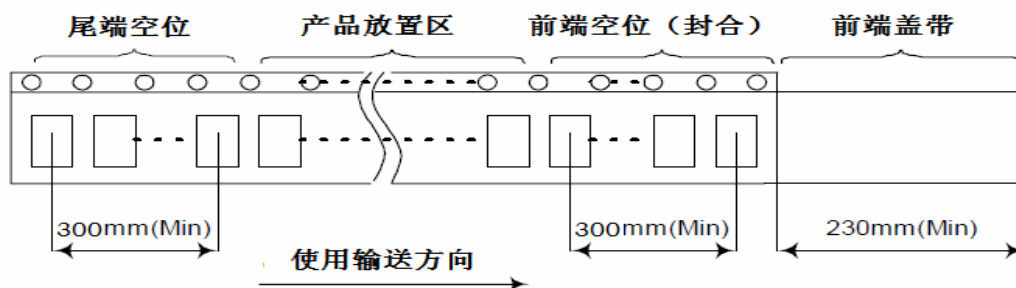





Dimension	L	L1	W	W1	Unit: mm
	178	13	11.5	8	3000pcs / reel







**SMD PRODUCT PACKING STANDARD**

**Out-going packing instruction**

Reel Packing	Inner Packing	Carton
name: reel standard: diameter 18cm material: plastics	name: Bubble Wrap standard: 430x330+20mm material: HDPE(15 reels enter)	name: carton standard: 400x400x280mm material: AB corrugated paper(4 bags enter)
		
		

**The label instruction**

Label Drawing	Mark	Name of Article	Spec.	Size	Printing
<p>PART NO : 3526000389</p> <p>LOT NO : 20041400</p> <p>Q'TY : 3000</p> <p>FREQ : 26.000000MHz</p>  <p>惠伦晶体 FAITH LONG CRYSTAL</p> <p>MADE IN CHINA</p>	L1	条码标签 Bar Code Label (Chintz Paper)	1.Part No. 2.Lot No. 3.Q'ty 4.Freq	70x50mm	White
<p>PART NO : 3526000389</p> <p>DATE CODE: 2015</p> <p>Q'TY : 30000</p> <p>FREQ : 26.000000MHz</p>  <p>惠伦晶体 FAITH LONG CRYSTAL</p> <p>MADE IN CHINA</p>	L2	条码标签 Bar Code Label (Chintz Paper)	1.Part No. 2.Date Code 3.Q'ty 4.Freq	70x50mm	White

**Remark**

Specifications on the label is for the use of templates with different product specifications may vary.  
If customer specified requirements for labels packaging, please provide the operation procedure.



Range	Products	Packing Material
Banned Substances	Maximum concentration ppm(mg/kg)	Maximum concentration ppm(mg/kg)
1.镉及镉化合物 Cadmium and cadmium compounds	100	100
2.铅及铅化合物 Lead and lead compounds	1000	100
3.汞及汞化合物 Mercury and mercury compounds	1000	100
4.六价铬化合物 Hexavalent-Chromium VI (Cr+6)	1000	100
5.聚溴联苯 PBB Polybrominated biphenyls	1000	N/A
6.聚溴二苯醚 PBDE Polybrominated diphenyl ethers	1000	N/A
7.邻苯二甲酸二(2-乙基己基)酯 DEHP Di (2-ethylhexyl) phthalate	1000	N/A
8.邻苯二甲酸丁苄酯 BBP Butyl Benzyl Phthalate	1000	N/A
9.邻苯二甲酸二丁酯 DBP Dibutyl Phthalate	1000	N/A
10 邻苯二甲酸二异丁酯 DIBP Diisobutyl Phthalate	1000	N/A
11. 氟 (F)、氯 (Cl)、溴 (Br)、碘 (I) Fluorine、Chlorine、Bromine、Iodine	900、900、900、900 注: Br+Cl<1000	N/A
12.包装材料中重金属(汞、镉、六价铬、铅、PBB、PBDE)之总量 Heavy metals (mercury, cadmium, lead, Cr+6,PBB and PBDE) in packing materials	N/A	100 铅(Pb) + 镉(Cd) + 汞(Hg) + 六价铬(Cr+6) <100ppm
13.高度关注物质 SVHC-Substances of Very High Concern	1000	N/A

