



# PRODUCT SPECIFICATION SHEET

CUSTOMER : \_\_\_\_\_  
PRODUCT TYPE : OSC 7.0X5.0 (4PAD)  
NOMINAL FREQ. : 50.000000 MHz  
FL P/N : 7C50090001  
REVISION : S0  
CUSTOMER P/N : \_\_\_\_\_

## CUSTOMER'S APPROVAL&DATE

--

## FL CORPORATION

APPROVED	CHECKED	DESIGNED
Xing Yue	Huang Ji Ning	Li Xiang

MSL1  
RoHS Compliant



## CONTENTS

## PAGE

- SPECIFICATION REVISION RECORD SHEET 2
- ELECTRICAL SPECIFICATIONS 3
- DIMENSIONS & MARKING 4
- STRUCTURE ILLUSTRATION 5
- RELIABILITY TEST SPECIFICATIONS 6
- PACKAGING REQUIREMENT 7/8
- SPECIFICATION OF THE ENVIRONMENT-RELATED SUBSTANCES 9

## ATTACHMENT ( optional )

- ELECTRICAL CHARACTERISTICS TEST A  YES  NO
- TEMPERATURE CHARACTERISTICS TEST B  YES  NO





## ELECTRICAL SPECIFICATIONS

### Standard atmospheric conditions

Unless otherwise specified. The standard range of atmospheric conditions for making measurement and tests are as follow:

Ambient temperature  $25\pm 2^{\circ}\text{C}$   
Relative humidity 40%~70%

If there is no doubt the results, measurement shall be made within the following limits:

Ambient temperature  $25\pm 2^{\circ}\text{C}$   
Relative humidity 40%~70%

### Measure equipment

Electrical characteristics measured by S&A 280A or equivalent.

### Crystal cutting type

The crystal is using AT CUT (thickness shear mode)

## ELECTRICAL SPECIFICATIONS

Parameters	Symbol	Electrical Spec.	UNITS	Notes
Nominal Frequency	FL	50.000000	MHz	-
Operating Temperature	TOPR	-40 ~ +85	$^{\circ}\text{C}$	-
The Total Frequency Offset	-	+/-50	ppm	-
Output Load	CL	20.0	p F	Max.
Supply Voltage	VDD	3.3	V	-
"0"Level	VOL	VDD $\times$ 0.1	V	Max.
"1"Level	VOH	VDD $\times$ 0.9	V	Min.
Enable High Voltage	ELH	VDD $\times$ 0.7	V	Min.
Enable Low Voltage	ELL	VDD $\times$ 0.3	V	Max.
Symmetry of Wave Form	Symmetry	45~55%		-
Current Consumption	IDD	10.0	m A	Max.
Rise and Fall Time	Tr,Tf	10.0	nSec	Max.
Start time	tosc	10.0	mSec	Max.
Aging	-	+/-5	ppm	1st Year
Storage Temperature Range	-	-55 ~ +125	$^{\circ}\text{C}$	-
Output waveform		HCMOS		-
ESD	-	HBM>2000V	-	JESD22-A114-B
MSL	-	Level 1	-	IPC/JEDEC J-STD-033C



**DIMENSION:**

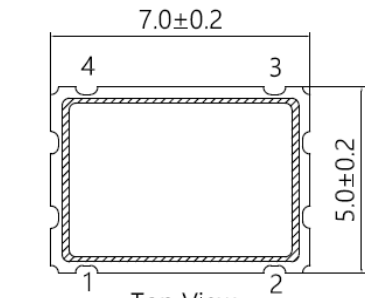

Top View

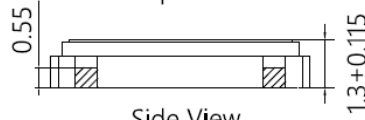

Side View

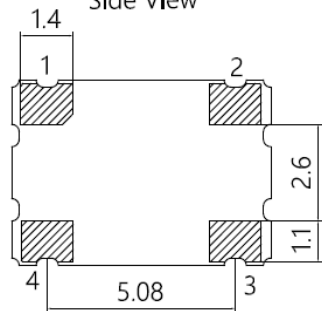

Bottom View

**PAD FUNCTION**

- 1: ENABLE CONTROL
- 2: GND
- 3: OUT
- 4: VDD

**Enable Control**

Pad 1 Input	Pad 3 Output
Level High or Open	Normal Operation
Level Low	Stopped

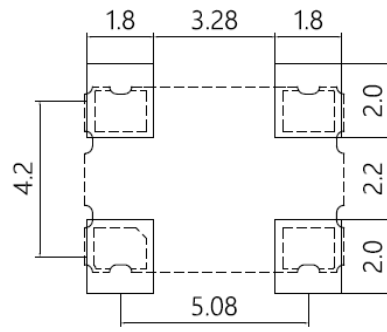

Top View Suggested Layout

**MARKING**

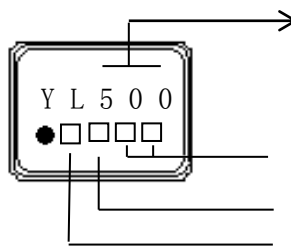

Frequency

Ex: 500=50.000MHz

Lot (2 digits)

Year Month Code

Administrative Symbol

		month											
year		JAN	FEB	MAR	APR	MAY	JUN	JUL	AUG	SEP	OCT	NOV	DEC
2021	2025	A	B	C	D	E	F	G	H	J	K	L	M
2022	2026	N	P	Q	R	S	T	U	V	W	X	Y	Z
2023	2027	a	b	c	d	e	f	g	h	j	k	l	m
2024	2028	n	p	q	r	s	t	u	v	w	x	y	z

**SUGGESTED REFLOW PROFILE**

Total time : 360 sec. Max.

Solder melting point :185 °C

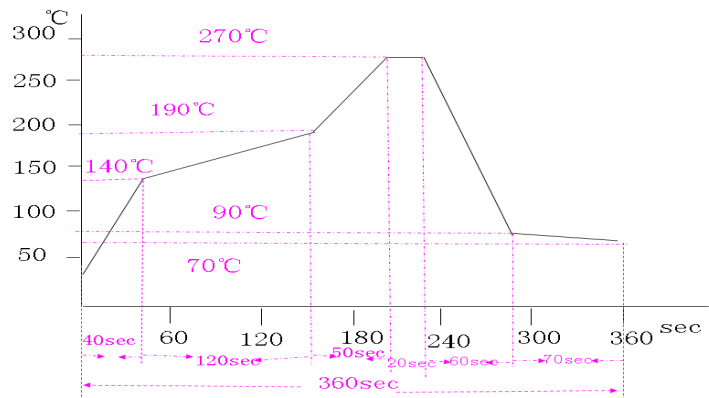



### STRUCTURE ILLUSTRATION

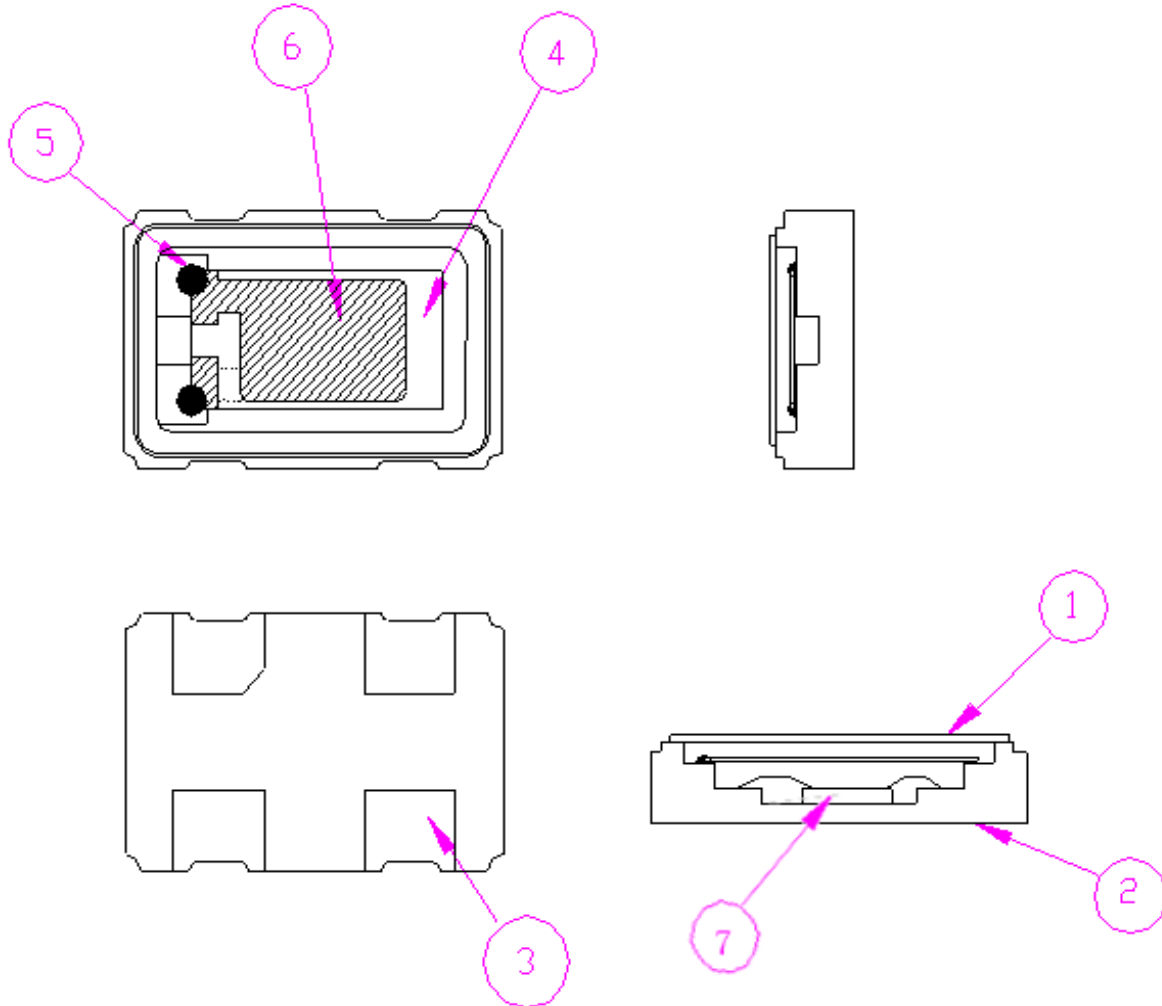

NO	COMPONENTS	MATERIALS	QTY	FINISH/SPECIFICATIONS
1	Cap (Lid)	Metal (Fe)	1	-
2	Base (Package)	Ceramic (Al <sub>2</sub> O <sub>3</sub> )	1	Alumina ceramics
3	Pad (Package)	Au	4	Tungsten metalize +Ni plating +Au plating
4	Crystal blank	SiO <sub>2</sub>	1	-
5	Conductive adhesive	Ag	4	Silicone resin
6	Electrode	Noble metal	2	-
7	IC	Silicon (Si)	1	-



## RELIABILITY SPECIFICATIONS

### 1.MECHANICAL ENDURANCE

No.	Test Item	Test Methods	
1	Drop Test	75 cm height, fall freely onto stainless plate 3 times.	JIS C6701
2	Mechanical Shock	Device are shocked to half sine wave ( 1000 G ) three mutually pendicular axes each 3 times. 0.5m sec. duration time	MIL-STD-202F
3	Vibration	Frequency range 10 ~ 2000 Hz Amplitude 1.52 mm Sweep time 20 minute Pendicular axes each test time 4 hours (Total test time 12 hours)	MIL-STD-883E
4	Solderability	Temperature 260 °C +/- 5 °C , 5 +/-1 sec Immersing depth 0.5 mm minimum Immersion time 10 +/- 0.5 seconds Flux Rosin resin methyl alcohol solvent ( 1 : 4 )	MIL-STD-883E
5	Resistance To Soldering Heat	Pre-heat temperature 125 °C Pre-heat time 60 ~ 120 sec. Test temperature 260 +/- 5 °C Test time 5 +/- 1 sec.	MIL-STD-202F

\*Storage conditions : 18 months

\*Constant humidity : 40~70%

### 2.ENVIRONMENTAL ENDURANCE

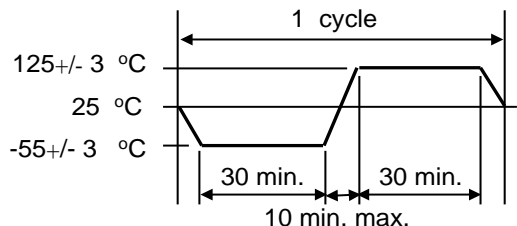
No.	Test Item	Test Methods	
6	High Temp. Storage	+ 125 °C +/- 2 °C for 1000 +/- 12 hours	MIL-STD-883E
7	Low Temp. Storage	- 40 °C +/- 2 °C for 1000 +/- 12 hours	
8	Thermal Shock	Total 10 cycles of the following temperature cycle  	MIL-STD-883E
9	High Temp. Operation	+ 85°C, VCC, for 1000 hours	MIL-STD-883E
10	Low Temp. Operation	- 40°C, VCC, for 1000 hours	MIL-STD-883E



**PACKING :**

16mm-8mm, 1000pcs / reel,  $\phi$  178;

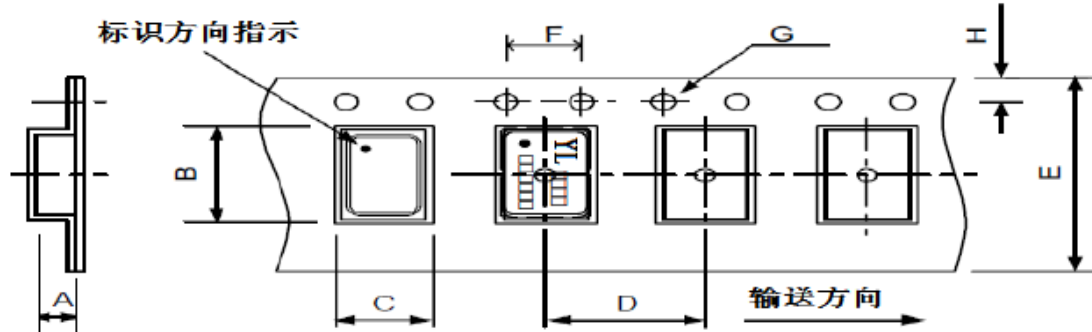

尺寸	A	B	C	D	E	F	G	H	单位:
	2.00	7.90	5.45	8.00	16.00	4.00	1.5	1.75	mm
	$\pm 0.1$	$\pm 0.1$	$\pm 0.1$						

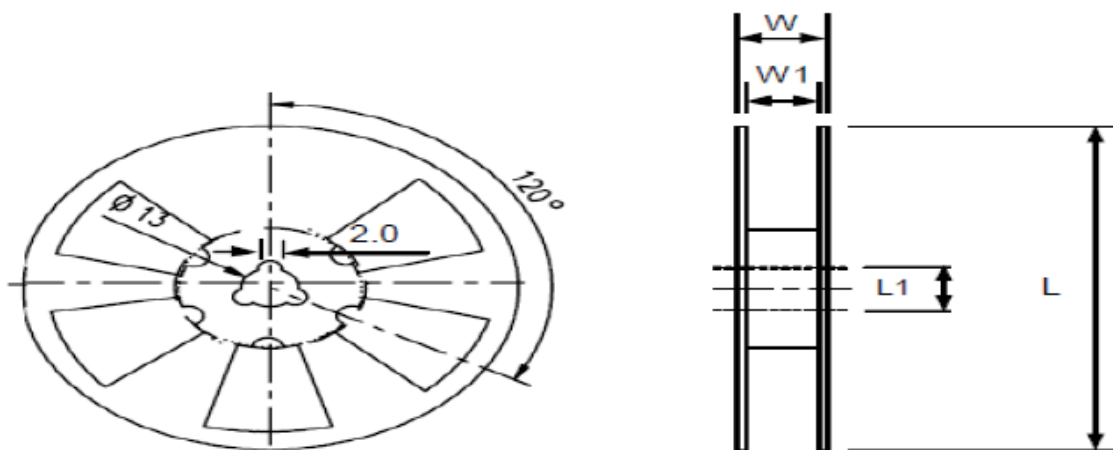
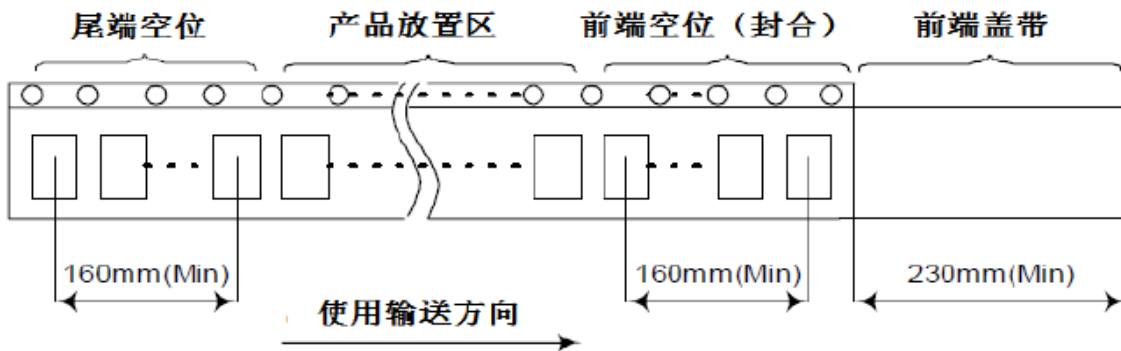

尺寸	L	L1	W	W1	单位: mm
	178	13	20.5	16	每卷数量: 1000 支















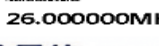

### SMD PRODUCT PACKING STANDARD

#### Out-going packing instruction

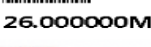
Reel Packing	Inner Packing	Carton
name: reel standard: diameter 18cm material: plastics name: Anti-Static Shielding Bag standard: 205x250mm material: APET/CPP	name: Anti-Static Bubble Bags standard: 430x330+20mm material: HDPE(15 reels enter)	name: carton standard: 400x400x280mm material: AB corrugated paper (40 boxes enter)
		
	PART NO : 3526000389  LOT NO : 20041400  Q'TY : 3000  FREQ : 26.000000MHz    惠伦晶体 FAITH LONG CRYSTAL MADE IN CHINA	

#### The label instruction

Label Drawing	Mark	Name of Article	Spec.	Size	Printing
PART NO : 3526000389  LOT NO : 20041400  Q'TY : 3000  FREQ : 26.000000MHz    惠伦晶体 FAITH LONG CRYSTAL MADE IN CHINA	L1	条码标签 Bar Code Label (Chintz Paper)	1.Part No. 2.Lot No. 3.Q'ty 4.Freq	70x50mm	White
PART NO : 3526000389  DATE CODE: 2015  Q'TY : 30000  FREQ : 26.000000MHz    惠伦晶体 FAITH LONG CRYSTAL MADE IN CHINA	L2	条码标签 Bar Code Label (Chintz Paper)	1.Part No. 2.Date Code 3.Q'ty 4.Freq	70x50mm	White

#### Remark

Specifications on the label is for the use of templates with different product specifications may vary.  
If customer specified requirements for labels packaging, please provide the operation procedure.



**广东惠伦晶体科技股份有限公司**  
GUANGDONG FAITH LONG CRYSTAL TECHNOLOGY Co.,Ltd.

TEL : +86(0)769-38879888  
FAX : 86(0)769-38879889

FL P/N: 7C50090001

VER: S0 PAGE: 9/9

Range	Products	Packing Material
Banned Substances	Maximum concentration ppm(mg/kg)	Maximum concentration ppm(mg/kg)
1.镉及镉化合物 Cadmium and cadmium compounds	100	100
2.铅及铅化合物 Lead and lead compounds	1000	100
3.汞及汞化合物 Mercury and mercury compounds	1000	100
4.六价铬化合物 Hexavalent-Chromium VI (Cr+6)	1000	100
5.聚溴联苯 PBB Polybrominated biphenyls	1000	N/A
6.聚溴二苯醚 PBDE Polybrominated diphenyl ethers	1000	N/A
7.邻苯二甲酸二(2-乙基己基)酯 DEHP Di (2-ethylhexyl) phthalate	1000	N/A
8.邻苯二甲酸丁苄酯 BBP Butyl Benzyl Phthalate	1000	N/A
9.邻苯二甲酸二丁酯 DBP Dibutyl Phthalate	1000	N/A
10 邻苯二甲酸二异丁酯 DIBP Diisobutyl Phthalate	1000	N/A
11. 氟 (F)、氯 (Cl)、溴 (Br)、碘 (I) Fluorine、Chlorine、Bromine、Iodine	900、900、900、900 注: Br+Cl<1000	N/A
12.包装材料中重金属(汞、镉、六价铬、铅、PBB、PBDE)之总量 Heavy metals (mercury, cadmium, lead, Cr+6,PBB and PBDE) in packing materials	N/A	100 铅(Pb) + 镉(Cd) + 汞(Hg) + 六价铬 (Cr+6) <100ppm
13.高度关注物质 SVHC-Substances of Very High Concern	1000	N/A

