



PRODUCT SPECIFICATION SHEET



Customer	-		
Customer P/N	TBA		
Product Type	Temperature Sensing Crystal		
Part Number	9Z38400006	Version	S0
Part Description	SMD TSX 2.0 x 1.6 (TH + Xtal)		
Nominal Frequency	38.400000 MHz		

Prepared	Li Xiang
Reviewed	Kuro Peng
Approved	Xing Yue
Date	2023-2-2

Customer's Approval & Date :

廣東惠倫晶體科技股份有限公司

中国广东省东莞市黄江镇东环路鸡啼岗段68号
 68 Donghuan Road, Jitigang Village, Huangjiang,
 Dongguan, Guangdong Province, P. R. China



WEB : <http://www.dgylec.com/>

TEL : +86 (0) 769 - 38879888

FAX : +86 (0) 769 - 38879889

EMAIL : yl@dgylec.com



Moisture Sensitivity Level 1

CONTENTS

#	Item	Page
1	History of Specification Revision	3
2	Electrical Specifications	4
	2.1 Specifications for operation condition and electrical characteristics	4
	2.2 Specifications for crystal drive level dependency (DLD)	5
	2.3 Specifications for GPS quality	6
	2.4 NTC thermistor specification table	7
3	Product Design	8
	3.1 Package dimensions and pad functions	8
	3.2 Recommended land pattern	8
	3.3 Recommended reflow profile	8
	3.4 Marking definition	9
	3.5 Recommended reflow profile	9
	3.6 Structure illustration	10
4	Taping and Packing	11
	4.1 Tape and reel	11
	4.2 Packing standard	12
5	Specification of the Environment-related Substances	13

1. History of Specification Revision

Ver.	Content	Date	Reviser	Remark
S0	Initial released	2023-2-2	Li Xiang	

2. Electrical Specifications

2.1 Specifications for operation condition and electrical characteristics

#	Parameter	Min.	Typ.	Max.	Unit	Remark
1	Nominal frequency	38.400000			MHz	-
2	Crystal cut type	AT-cut			-	-
3	Mode of vibration	Fundamental			-	-
4	ESD	HBM > 2000V				JESD22-A114-B
5	MSL	Level 1				IPC/JEDEC J-STD-033C
6	Load capacitance (C _L)	-	8.0	-	pF	Note 1.
7	Drive level	10	100	200	μW	-
8	Operating temperature range	-40	-	+105	°C	-
9	Storage temperature range	-40	-	+105	°C	-
10	Initial frequency tolerance	-10	-	+10	ppm	At 25±3°C, drive level 10μW
11	Frequency drift after reflow	-2.0	-	+2.0	ppm	After two times of reflow
12	Frequency tolerance over temperature	-12	-	+12	ppm	-30°C to +85°C.
		-30	-	+30	ppm	-40°C to +105°C.
13	Frequency aging	-0.7	-	+0.7	ppm/yr	-
14	Equivalent series resistance (ESR)	-	-	50	Ω	Note 2.
15	Insulation resistance	500	-	-	MΩ	-
16	Quality factor (Q)	75,000	-	-	-	Note 3.
17	Spurious mode series resistance	1,100	-	-	Ω	Within ±1 MHz offset.
18	Pullability	7	-	16	ppm/pF	-
19	Inflection point	27.5	29	30.5	°C	Specified at max drive level. $t = \left(t_0 - \frac{C2}{3C3} \right)$
20	First-order curve fitting parameter (C1)	-0.4	-	-0.1	ppm/°C	-
21	Second-order curve fitting parameter (C2)	-4.5	0	+4.5	x10 ⁻⁴ ppm/°C ²	-
22	Third-order curve fitting parameter (C3)	+8.5	+10.0	+11.5	x10 ⁻⁵ ppm/°C ³	-

Note 1 The load capacitance is measured according to IEC Standard #60444-8.

Note 2 The ESR max is specified at max drive level minimum Q, drives a smaller ESR; that is, design the crystal to the minimum Q.

Note 3 The minimum Q value calculated from ESR and L is smaller than this specification.

2. Electrical Specifications (Cont.)

2.2 Specifications for crystal drive level dependency (DLD)

#	Parameter	Min.	Typ.	Max.	Unit	Remark
1	Drive level measurement condition	0.01	-	200	μW	Drive level from 0.01 μW to 200 μW to 0.01 μW
2	Number of points	29			points	15 points up and 15 points down = 29 total data points.
3	DLD frequency (maximum - minimum)	-	-	6	ppm	Define as FDLD. Note 6.
4	DLD frequency (repeatability)	-	-	0.7	ppm	Define as FDLDH. Note 7.
5	DLD ESR (maximum - minimum)	-	-	20	%	Define as DLD10.
6	DLD ESR (repeatability)	-	-	10	%	Define as DLDH3. Note 7 and Note 8.

Note 6 Maximum - minimum: Difference between the maximum and minimum in a two-way measurement.

Note 7 Repeatability of the two-way measurement is defined in the above Drive level measurement condition.

Note 8 For DLD ESR (Repeatability), the change rate is defined as $(\text{ESR2} - \text{ESR1})/\text{ESR1}$.

Note 9 ESR1: This is the first measurement on each drive level.

Note 10 ESR2: This is the second measurement on each drive level.

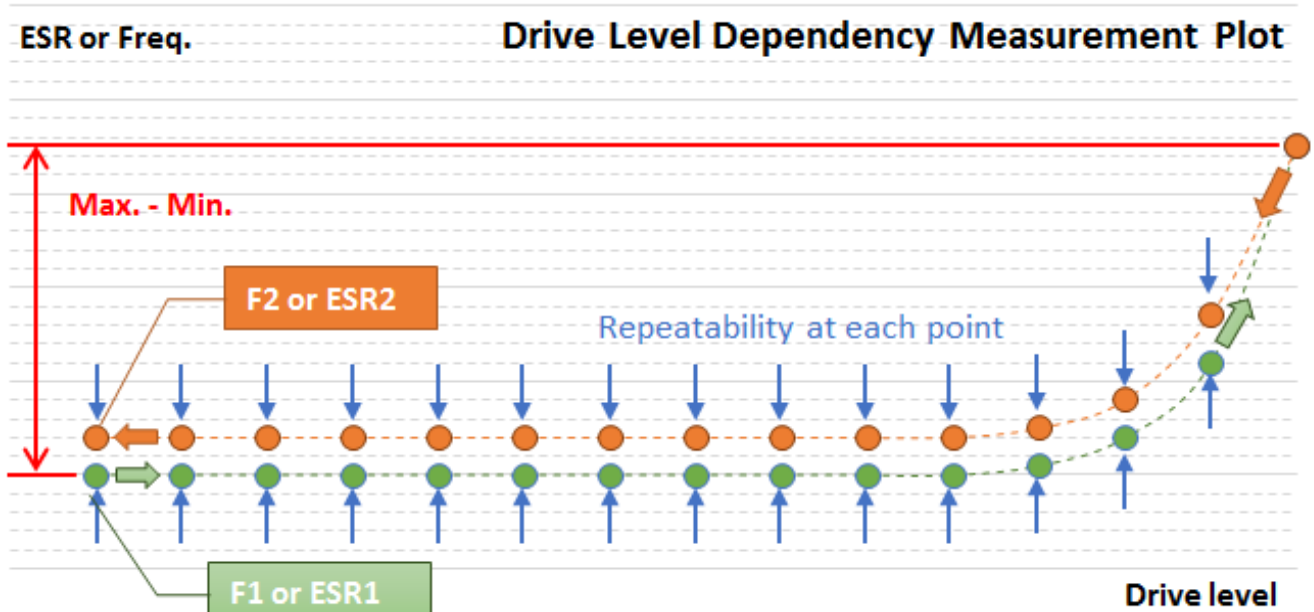

2. Electrical Specifications (Cont.)

2.3 Specifications for GPS quality

#	Parameter	Min.	Typ.	Max.	Unit	Remark
1	Residual frequency stability slope	-50	-	+50	ppb/°C	Within -30°C to -85°C. Note 13 and Note 14 (Condition 1A).
2	5°C small orbit hysteresis 1	-50	-	+50	ppb/°C	Within -30°C to -85°C. Note 15 (Condition 1B).
3	5°C small orbit hysteresis 2	100 (magnitude)			ppb pk-pk	Within -30°C to +85°C. Note 16.

Note 13 Residual = difference from fifth-order curve fit. Must meet below 1A (Note 14) and 1B (Note 15) conditions:

Note 14 Condition 1A – Test condition (continuous temperature rate change of ~1.0°C/min.):

- Measure F/T points every 1°C, heating up from -40 to +105°C, subtract a fifth-order polynomial best fit and then calculate the slope of the residual.

Note 15 Condition 1B – Hysteresis 1 test condition (continuous temperature rate change of ~1.0°C/minute):

- Measure F/T points every 0.5°C while cycling temperature over a 5°C small temperature orbit; an example 5°C small orbit temperature cycle is +30°C to +35°C to +30°C.
- During every individual heating/cooling cycle, there should be 11 points. Discard the first point of each heating and cooling cycle. This leaves 10 points for each heating and cooling cycle. Subtract the fifth-order polynomial best fit from 1A for each of the 10 points, and then calculate the slope of the residual for each of these heating and cooling 10 point curves.

Note 16 Hysteresis 2 test condition (continuous temperature rate change of ~1.0°C/min.):

- Measure F/T points every 0.5°C while cycling temperature over a 5°C small temperature orbit; an example 5°C small orbit temperature cycle is +30°C to +35°C to +30°C.
- During every individual heating/cooling cycle there should be 11 points; discard the first and last point of each heating and cooling cycle, which results in 9 temperature points. Calculate the average measured peak-to-peak frequency difference for these 9 temperature points.
- The average difference is the magnitude of the small orbit hysteresis 2.

2. Electrical Specifications (Cont.)

2.4 NTC thermistor specification table

#	Parameter	Min.	Typ.	Max.	Unit	Remark
1	Operating temperature range	-40	-	+105	°C	-
2	Storage temperature range	-40	-	+105	°C	-
3	Resistance	-	100	-	kΩ	At 25°C
4	B-constant	-	4,250	-	K	At 25°C - 50°C
5	Tolerance	-	-	1	%	-

*In order to get the precise resistance value of the thermistor, the temperature control will be very important during testing since the resistance value will change ~4% per 1°C temperature difference.

Please check the following Murata website for detail explanation.

<https://www.murata.com/en-us/support/faqs/products/thermistor/ntc/pct/0001>

3. Product Design

3.1 Package dimensions and pad functions (Unit : mm)

3.2 Pad connection diagram and function

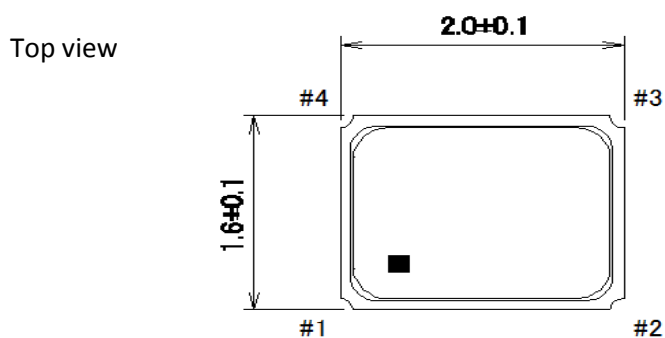

Bottom view

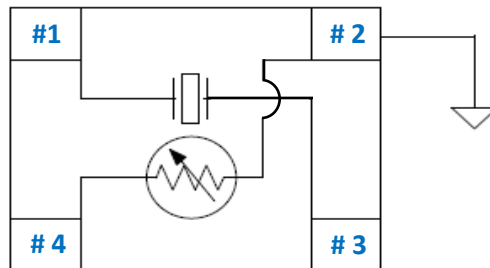

Lateral view

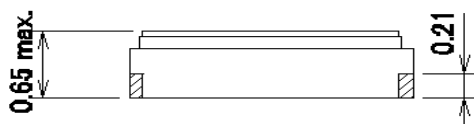

Bottom view

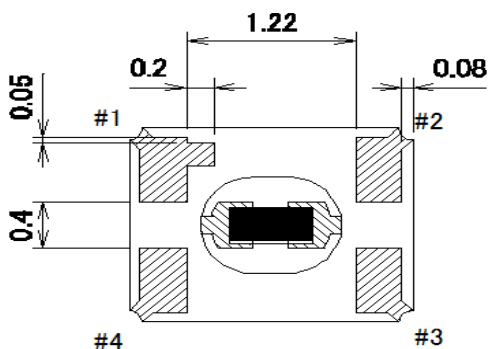

Pad	Function
1	Xtal in
2	Thermistor out, connecting to ground
3	Xtal out
4	Thermistor in

3.3 Recommended land pattern (Unit : mm)

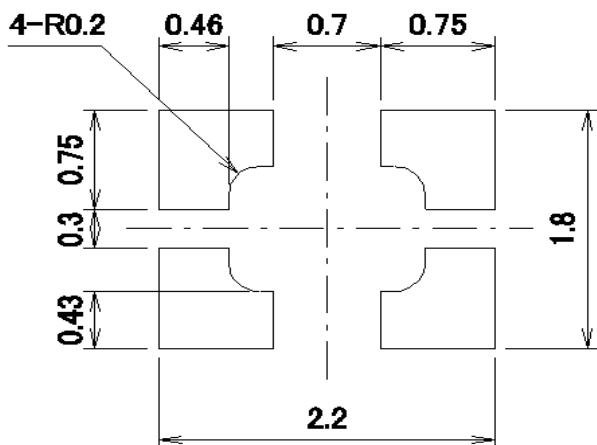

3. Product Design (Cont.)

3.4 Marking definition

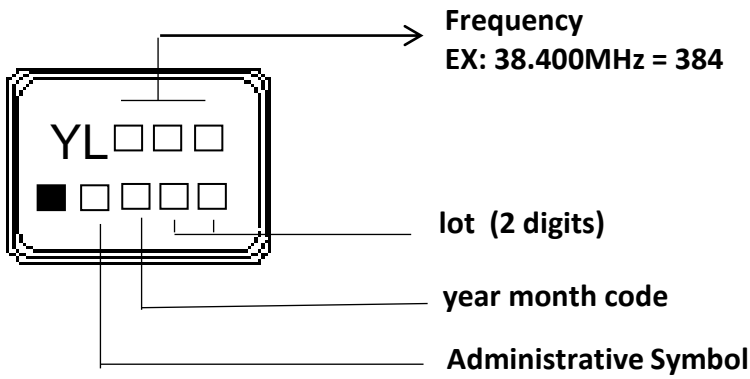
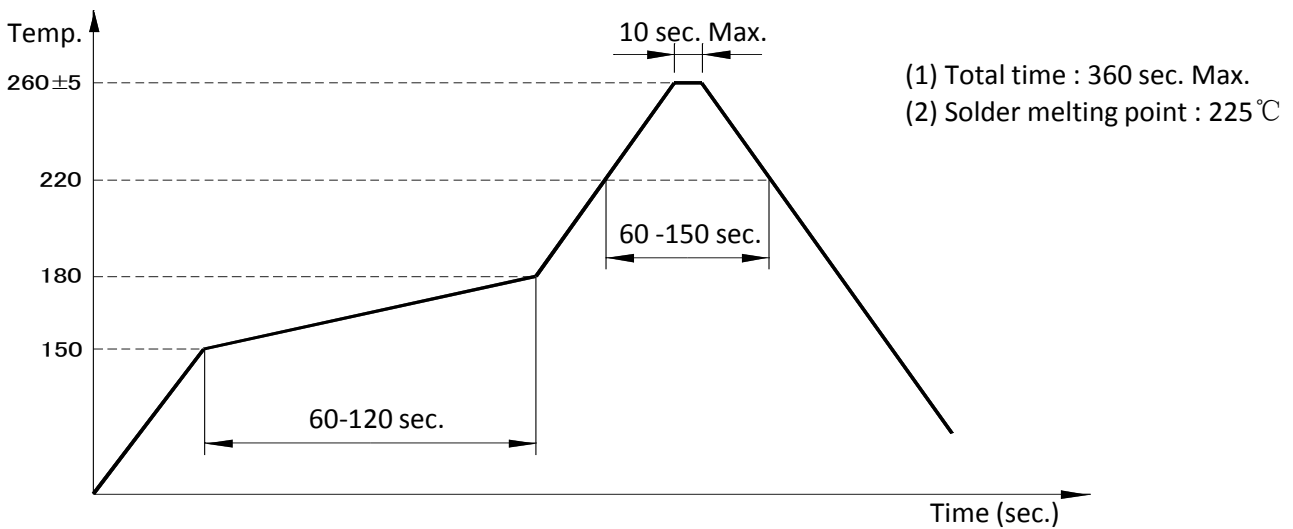

Table of Year and Month code

		Month											
Year		JAN	FEB	MAR	APR	MAY	JUN	JUL	AUG	SEP	OCT	NOV	DEC
2021	2025	A	B	C	D	E	F	G	H	J	K	L	M
2022	2026	N	P	Q	R	S	T	U	V	W	X	Y	Z
2023	2027	a	b	c	d	e	f	g	h	j	k	l	m
2024	2028	n	p	q	r	s	t	u	v	w	x	y	z

3.5 Recommended reflow profile



3. Product Design (Cont.)

3.6 Structure illustration

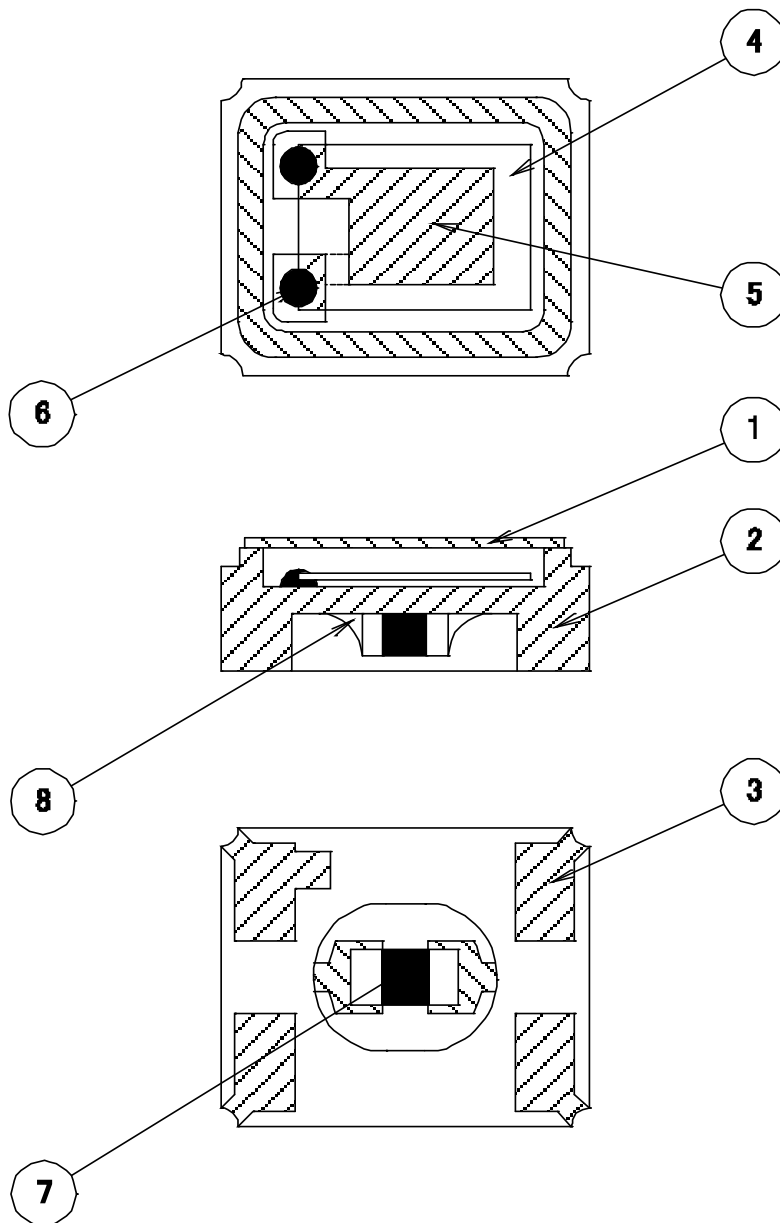

#	Components	Materials	QTY	Finish/Specifications
1	Cap (Lid)	Kovar (Fe + Co + Ni)	1	Ni plating
2	Base (Package)	Ceramic (Al ₂ O ₃) + Kovar (Fe + Co + Ni)	1	Alumina ceramics
3	Pad (Package)	Ni + Au	4	Tungsten metalization + Ni plating + Au plating
4	Crystal blank	SiO ₂	1	-
5	Electrode	Cr + Nobel material	2	
6	Conductive adhesive	Ag	2	Silicone resin
7	Thermistor	Alumina Ceramics (Al ₂ O ₃), Ni + Ag+ Sn	1	-
8	Solder	Sn + Ag + Cu	2	-

4. Taping and Packing

4.1 Tape and reel (EIA-481-2)

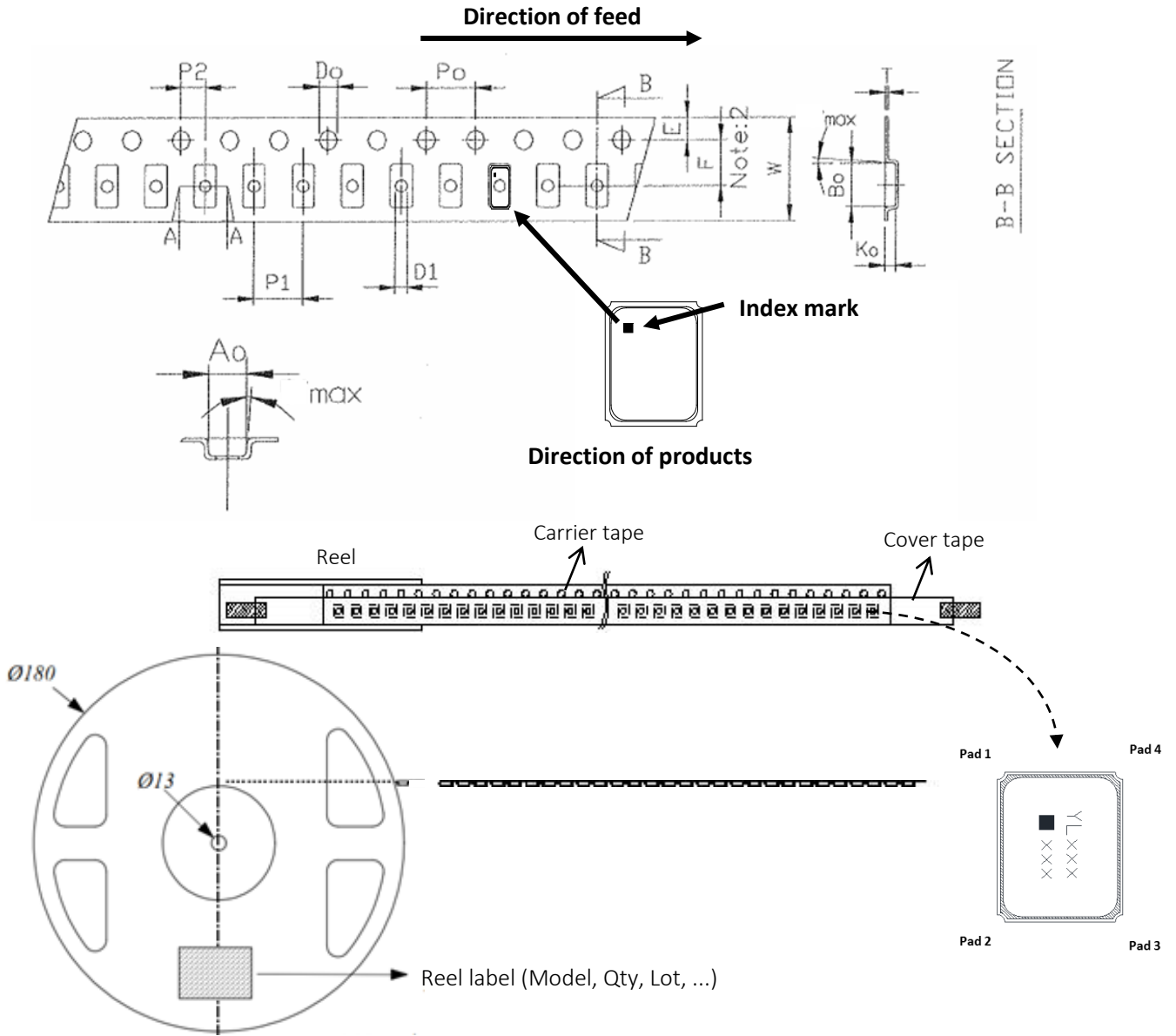

Package Type	Dimension (Unit : mm)						
2016 TSX(8mm)	A ₀	B ₀	K ₀	T	W	E	F
	1.9±0.1	2.3±0.1	1.25±0.10	0.25±0.05	8.00±0.3	1.75±0.1	3.50±0.1
	P1	P2	D1	D ₀	P ₀		
	4.00±0.1	2.00±0.1	1.00±0.05	1.55±0.05	4.00±0.1		

Standard Reel Quantity is 3000 pcs per reel.



The inspection standard of tape tension

Item		Defect	Method
Appearance	All	1. The tape is not coincidence 2. The bubble	Visual inspection
Tape tension	2016 8mm	Overstep 34±6g (28 to 40g)	Pull test



4. Taping and Packing (Cont.)

4.2 Packing standard

Out-going packing instruction

Reel packing	Inner packing	Carton
Name : Reel Standard : Diameter 18cm Material : Plastics Name : Anti-static shielding bag Standard : 205×250mm Material : APET/ CPP	Name : Bubble wrap Standard : 430×330×(t)20mm Material : HDPE Quantity : Max.15 reels	Name : Carton Standard : 400×400×(H)280mm Material : AB corrugated paper Quantity : 4 bags
		

The label information

Label	Label Drawing	Name of Article	Spec.	Label size	Printing
L1		条码标签 Bar Code Label (Chintz Paper)	1. Part No. 2. Lot No. 3. Q'ty 4. Freq.	70×50mm	White
L2		条码标签 Bar Code Label (Chintz Paper)	1. Part No. 2. Date Code 3. Q'ty 4. Freq.	70×50mm	White

Remark: Specifications on the label is for default templates purpose and may change with different product.
 If any specified requirements for labels packaging is needed, please provide the instruction information.

5. Specification of the Environment-related Substances

#	Range	Max. concentration (ppm; mg/kg)	
	Banned Substances	Product	Packing
1	镉及镉化合物 Cadmium and cadmium compounds	100	100
2	铅及铅化合物 Lead and lead compounds	1000	100
3	汞及汞化合物 Mercury and mercury compounds	1000	100
4	六价铬化合物 Hexavalent-Chromium VI (Cr ⁺⁶)	1000	100
5	聚溴联苯 PBB Polybrominated biphenyls	1000	N/A
6	聚溴二苯醚 PBDE Polybrominated diphenyl ethers	1000	N/A
7	邻苯二甲酸二(2-乙基己基)酯 DEHP Di (2-ethylhexyl) phthalate	1000	N/A
8	邻苯二甲酸丁苄酯 BBP Butyl Benzyl Phthalate	1000	N/A
9	邻苯二甲酸二丁酯 DBP Dibutyl Phthalate	1000	N/A
10	邻苯二甲酸二异丁酯 DIBP Diisobutyl Phthalate	1000	N/A
11	氟(F)、氯(Cl)、溴(Br)、碘(I) Fluorine, Chlorine, Bromine, Iodine	900、900、900、900 注：Br + Cl < 1000	N/A
12	包装材料中重金属(汞、镉、六价铬、铅、PBB、PBDE)之总量 Heavy metals (mercury, cadmium, lead, Cr ⁺⁶ , PBB and PBDE) in packing materials	N/A	100 铅(Pb) + 镉(Cd) + 汞(Hg) + 六价铬(Cr+6) <100ppm
13	高度关注物质 SVHC-Substances of Very High Concern	1000	N/A