



PRODUCT SPECIFICATION SHEET



Customer			
Customer P/N			
Product Type	Temperature Sensing Crystal		
Part Number	2Z26000010	Version	S0
Part Description	SMD TSX 2.5 x 2.0 (TH + Xtal)		
Nominal Frequency	26.000000MHz		

Prepared	Li Xiang
Reviewed	Kuro Peng
Approved	Xing Yue
Date	2022-7-1

Customer's Approval & Date :

广东惠伦晶体科技股份有限公司

中国广东省东莞市黄江镇东环路鸡啼岗段68号
68 Donghuan Road, Jitigang Village, Huangjiang,

Dongguan, Guangdong Province, P. R. China

WEB : <http://www.dgylec.com/>

TEL : +86 (0) 769 - 38879888

FAX : +86 (0) 769 - 38879889

EMAIL : yl@dgylec.com



Moisture Sensitivity Level 1

CONTENTS

#	Item	Page
1	History of Specification Revision	3
2	Electrical Specifications	4
	2.1 Specifications for operation condition and electrical characteristics	4
	2.2 Specifications for crystal drive level dependency (DLD)	5
	2.3 Specifications for GPS quality	5
	2.4 NTC thermistor specification table	5
3	Product Design	6
	3.1 Package dimensions and pad functions	6
	3.2 Recommended land pattern	6
	3.3 Recommended reflow profile	6
	3.4 Marking definition	7
	3.5 Recommended reflow profile	7
	3.6 Structure illustration	8
4	Reliability Assurance	9
	4.1 Mechanical endurance	9
	4.2 Environmental endurance	9
5	Taping and Packing	10
	5.1 Tape and reel	10
	5.2 Packing standard	11
6	Specification of the Environment-related Substances	12

1. History of Specification Revision

Ver.	Content	Date	Reviser	Remark
S0	Initial released	2022-7-1	Li Xiang	

2. Electrical Specifications

2.1 Specifications for operation condition and electrical characteristics

#	Parameter	Min.	Typ.	Max.	Unit	Remark
1	Nominal frequency	26.000000			MHz	-
2	Crystal cut type	AT-cut			-	-
3	Mode of vibration	Fundamental			-	-
4	Load capacitance (C _L)	-	9.0	-	pF	Note 1.
5	Drive level	-	-	100	μW	-
6	Operating temperature range	-30	-	+85	°C	-
7	Storage temperature range	-40	-	+85	°C	-
8	Initial frequency tolerance	-10	-	+10	ppm	At 25±3°
9	Frequency drift after reflow	-2.0	-	+2.0	ppm	After two times of reflow (0.5Hr freq. driftsubstruct 168Hr freq.)
10	Frequency tolerance over temperature	-10	-	+10	ppm	Within -25°C to +85°C. Above +85°C see Note 2.
11	Frequency aging	-1.0	-	+1.0	ppm/yr	at 25±2°C
		-1.5	-	+1.5	ppm/2yr	
		-2.5	-	+2.5	ppm/5yr	
		-5.0	-	+5.0	ppm/10yr	
12	Equivalent series resistance (ESR)	-	-	30	Ω	Note 3.
13	Insulation resistance	500	-	-	MΩ	at DC 100V
14	Quality factor (Q)	75,000	-	-	-	Note 4.
15	Spurious mode series resistance	500	-	-	Ω	Within ±1MHz offset.
16	Tuning Sensitivity	16.2	18	19.8	ppm/pF	-
17	G Sensitivity	-2	-	+2	ppb/G	-
18	First-order curve fitting parameter (C1)	-0.35	-0.225	-0.10	ppm/°C	Note 5.
19	Second-order curve fitting parameter (C2)	-12.0	-8.5	+5	x10 ⁻⁴ ppm/°C ²	Note 5.
20	Third-order curve fitting parameter (C3)	+8.7	+9.9	+11.0	x10 ⁻⁵ ppm/°C ³	Note 5.

The load capacitance is measured according to IEC Standard #60444-8.

Note 2 Above 85°C, the frequency tolerance over temperature is bound by the third order coefficient range.

Note 3 The ESR max is specified at max drive level minimum Q, drives a smaller ESR; that is, design the crystal to the minimum Q.

Note 4 The minimum Q value calculated from ESR and L is smaller than this specification.

Note 5 The curve fitting parameter is obtained from the QTI crystal curve fitting algorithm, using the temperature inflection point t₀ = 30.5°C.

2. Electrical Specifications (Cont.)

2.2 Specifications for crystal drive level dependency (DLD)

#	Parameter	Min.	Typ.	Max.	Unit	Remark
1	Drive level measurement condition	0.01	-	100	μW	Drive level from 0.01 μW to 100 μW to 0.01 μW
2	DLD Frequency (Maximum - Minimum)	-	-	2.0	ppm	Define as FDL D. Note 6.
3	DLD Frequency (Hysteresis)	-	-	0.7	ppm	Define as FDL D H. Note 7.
4	DLD ESR (Maximum - Minimum)	-	-	2.5	Ω	Define as DLD 2. Note 6.
5	DLD ESR (Hysteresis)	-	-	1.5	Ω	Define as DLD 2 H. Note 7~9.

Note 6 Maximum - minimum: Difference between the maximum and minimum in a two-way measurement.

Note 7 Repeatability of the two-way measurement is defined in the above Drive level measurement condition.

Note 8 ESR1: This is the first measurement on each drive level.

Note 9 ESR2: This is the second measurement on each drive level.

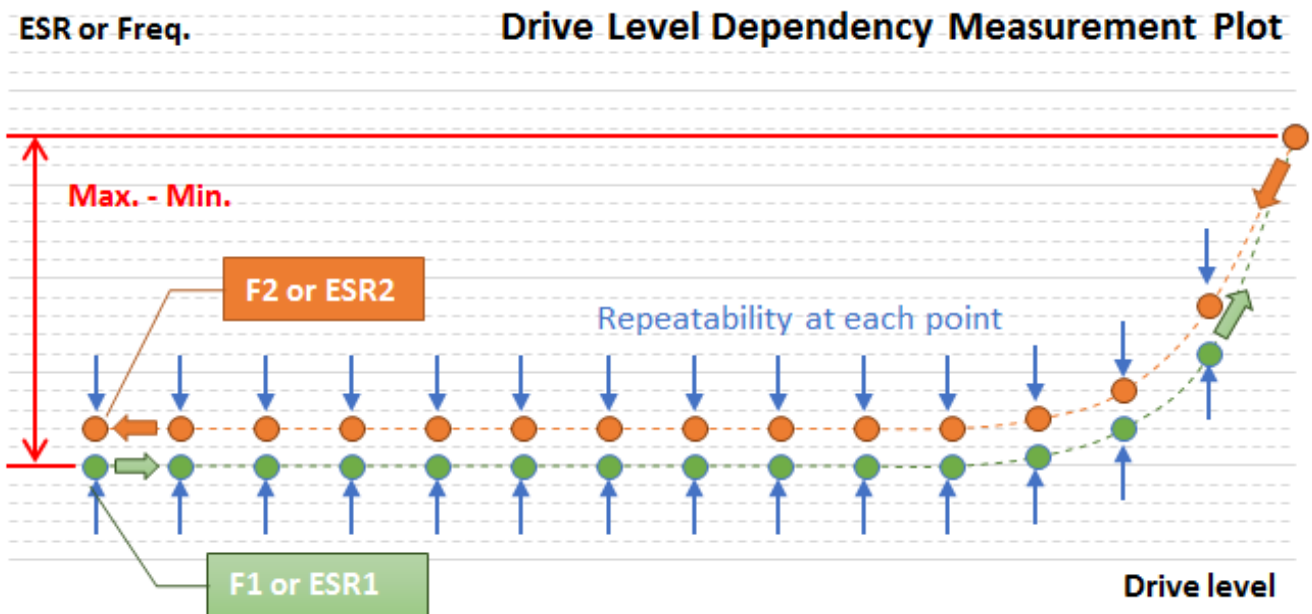

2. Electrical Specifications (Cont.)

2.3 Specifications for GPS quality

#	Parameter	Min.	Typ.	Max.	Unit	Remark
1	Frequency stability slope 1	-0.05	-	+0.05	ppm	At -10°C to +60°C. Note 10.
2	Frequency stability slope 2	-0.05	-	+0.05	ppm	At -30°C to +85°C. Note 10.
3	Full cycle temperature hysteresis	-0.5	-	+0.5	ppb/°C	At -40°C to +85°C. Note 11.
4	Small cycle temperature hysteresis	-0.05	-	+0.05	ppb/°C	Note 11.
5	Perturbation	-0.5	-	+0.5	ppb/°C	Note 11.

Note 10 Temp. range:-30 to 85°C for each 1°C, Temp. rate: ~1.0°C/min
 Test flow: 25°C(1)->-30°C->85°C->25°C(2), (25°C(1) freq. drift subtract 25°C(2) freq. drift)

Note 11 Test condition: Continuous temperature rate change of~ 1.0°C/min
 Measure FT points every 1°C, heating up from -30 to 85°C, subtract a fifth-order polynomial best fit, and then calculate the slope of the residual.

2.4 NTC thermistor specification table

#	Parameter	Min.	Typ.	Max.	Unit	Remark
1	Operating temperature range	-30	-	+85	°C	
2	Storage temperature range	-40	-	+85	°C	
3	Resistance	-	100	-	kΩ	At 25°C*
4	B-constant	-	4,250	-	K	At 25°C - 50°C
5	Tolerance	-1	-	1	%	
6	ESD	HBM > 2000V			-	JESD22-A114-B
7	MSL	Level 1			-	IPC/JEDEC J-STD-033C

*In order to get the precise resistance value of the thermistor, the temperature control will be very important during testing since the resistance value will change ~4% per 1°C temperature difference.

Please check the following Murata website for detail explanation.

<https://www.murata.com/en-us/support/faqs/products/thermistor/ntc/pct/0001>

3. Product Design

3.1 Package dimensions and pad functions (Unit : mm)

3.2 Pad connection diagram and function

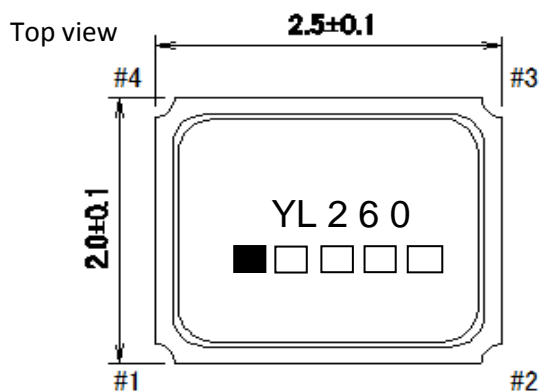

Lateral view



Bottom view

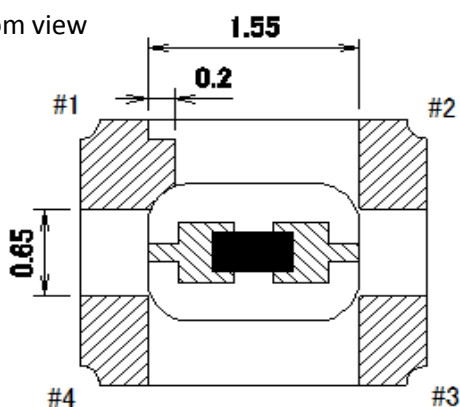

Bottom view

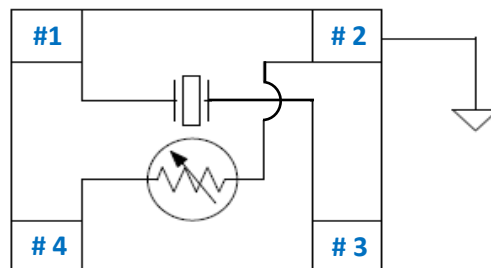

Pad	Function
1	Xtal in
2	Thermistor out, connecting to ground
3	Xtal out
4	Thermistor in

3.3 Recommended land pattern (Unit : mm)

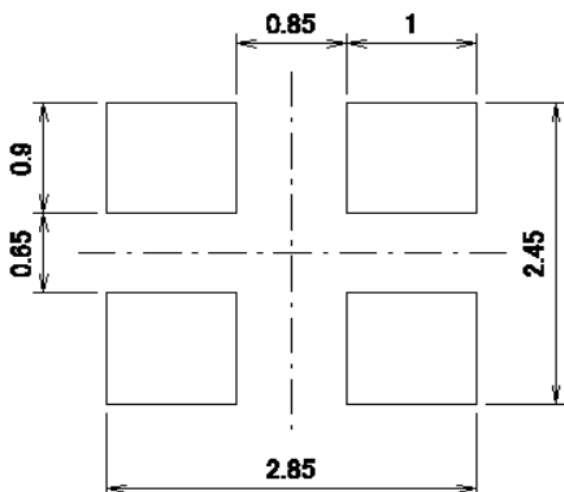

3. Product Design (Cont.)

3.4 Marking definition

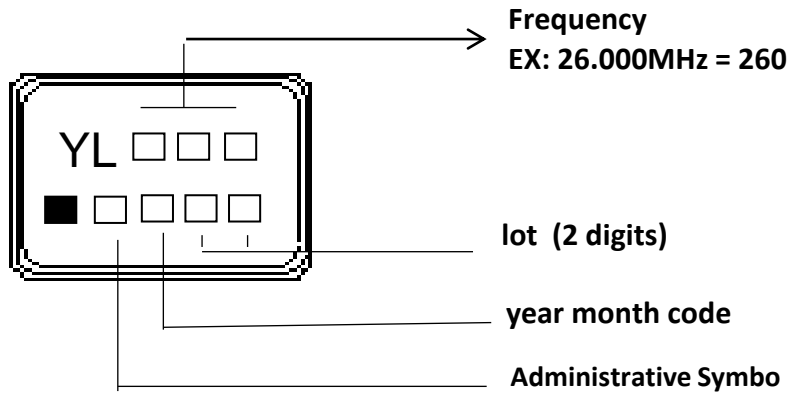
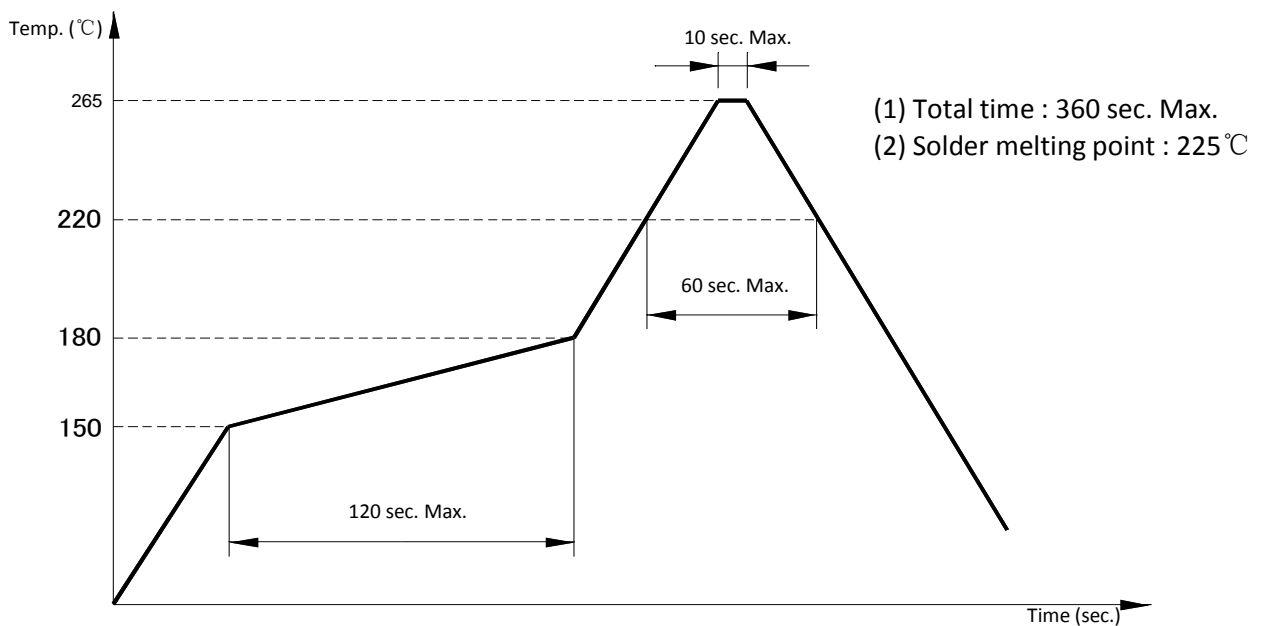

Table of Year and Month code

		Month											
Year		JAN	FEB	MAR	APR	MAY	JUN	JUL	AUG	SEP	OCT	NOV	DEC
2021	2025	A	B	C	D	E	F	G	H	J	K	L	M
2022	2026	N	P	Q	R	S	T	U	V	W	X	Y	Z
2023	2027	a	b	c	d	e	f	g	h	j	k	l	m
2024	2028	n	p	q	r	s	t	u	v	w	x	y	z

3.5 Recommended reflow profile



3. Product Design (Cont.)

3.6 Structure illustration

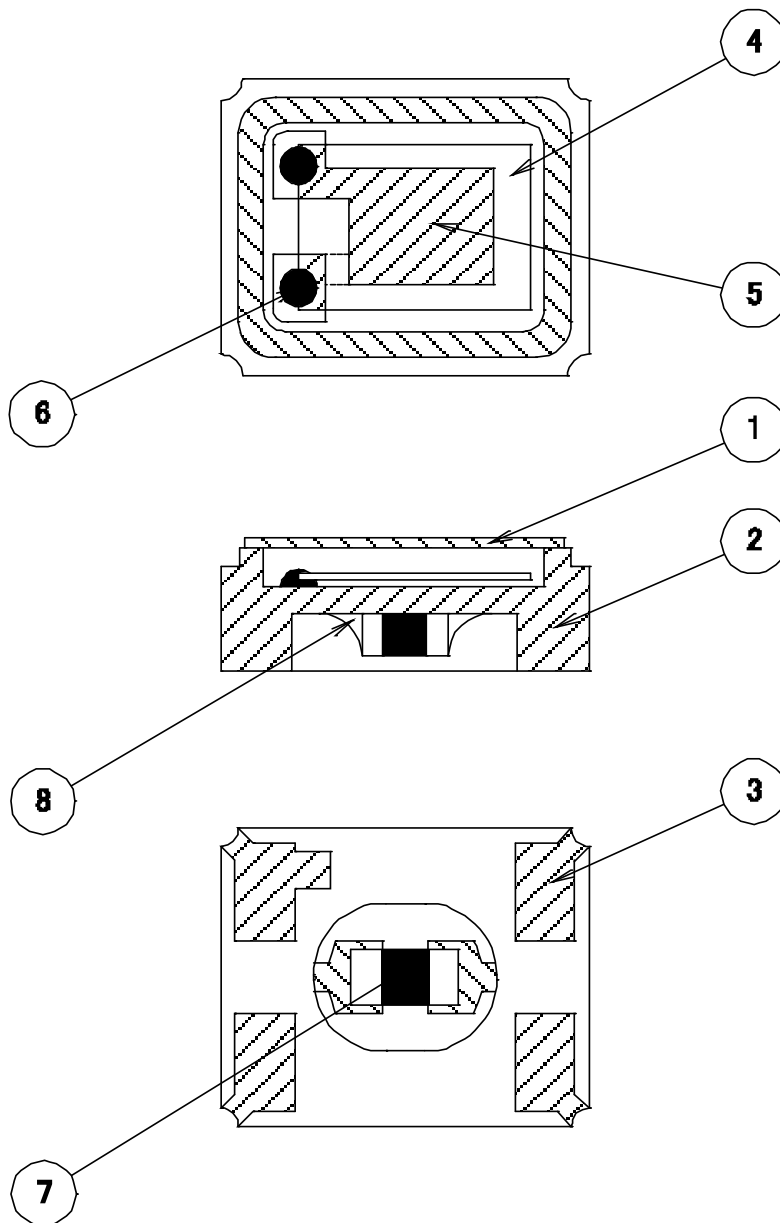

#	Components	Materials	QTY	Finish/Specifications
1	Cap (Lid)	Kovar (Fe + Co + Ni)	1	Ni plating
2	Base (Package)	Ceramic (Al ₂ O ₃) + Kovar (Fe + Co + Ni)	1	Alumina ceramics
3	Pad (Package)	Ni + Au	4	Tungsten metalization + Ni plating + Au plating
4	Crystal blank	SiO ₂	1	-
5	Electrode	Cr + Nobel material	2	
6	Conductive adhesive	Ag	2	Silicone resin
7	Thermistor	Alumina Ceramics (Al ₂ O ₃), Ni + Ag+ Sn	1	-
8	Solder	Sn + Ag + Cu	2	-



4. Reliability Assurance

4.1 Mechanical endurance

#	Item	Test Condition	Reference
1	Drop test	150 cm height, fall freely onto stainless plate, 3 times.	JIS C6701
2	Shock test	150 g weight, 150 cm height onto concrete floor. Each direction ($\pm x, \pm y, \pm z$) for 3 cycles.	IEC-68-02-27
3	Mechanical shock	Half sine wave 1000 G. Three mutually perpendicular axes, each axis for 3 times. Duration time 1.0ms.	MIL-STD-202F
4	Vibration	Frequency range : 10 ~ 55 Hz Amplitude : 1.52 mm Pencil axes each test time : 2 hours (x,y,z Axis) Total test time 6 hours	MIL-STD-883E
5	Gross Leak	Standard sample for automatic gross leak detector. Test pressure: 2kg /cm ² .	MIL-STD-883E
6	Fine Leak	Helium bombing 4.5 kgf/cm ² for 2 hours.	MIL-STD-883E
7	Solderability	Temperature : 260°C \pm 5°C Immersing depth : 0.5 mm minimum Immersion time : 5 \pm 1 seconds Flux : Rosin resin methyl alcohol solvent (1:4)	GB/T 2424.17-2008 / IEC 60068-2-44:1995; GB/T 2423.28-2005 / IEC 60068-2-20:1979
8	Resistance To Soldering Heat	Pre-heat temperature 125°C Pre-heat time 60 ~ 120 sec. Test temperature 260 \pm 5°C Test time 5 \pm 1 sec.	MIL-STD-202F

*Storage conditions : 18 months

*Constant humidity : 40~70%

4.2 Environmental endurance

#	Item	Test Condition	Reference
1	High temperature storage	Temperature : +125°C \pm 3°C Duration : 500 \pm 12 hours	MIL-STD-883E
2	Low temperature storage	Temperature : -40°C \pm 3°C Duration : 500 \pm 12 hours	MIL-STD-883E
3	Thermal shock (Air to Air)	Total 100 cycles of the following temperature cycle 	MIL-STD-883E
4	High temperature & humidity	Temperature : 85°C \pm 3°C Humidity : RH 85% Duration : 500 hours	JIS C5023

5. Taping and Packing

5.1 Tape and reel (EIA-481-2)

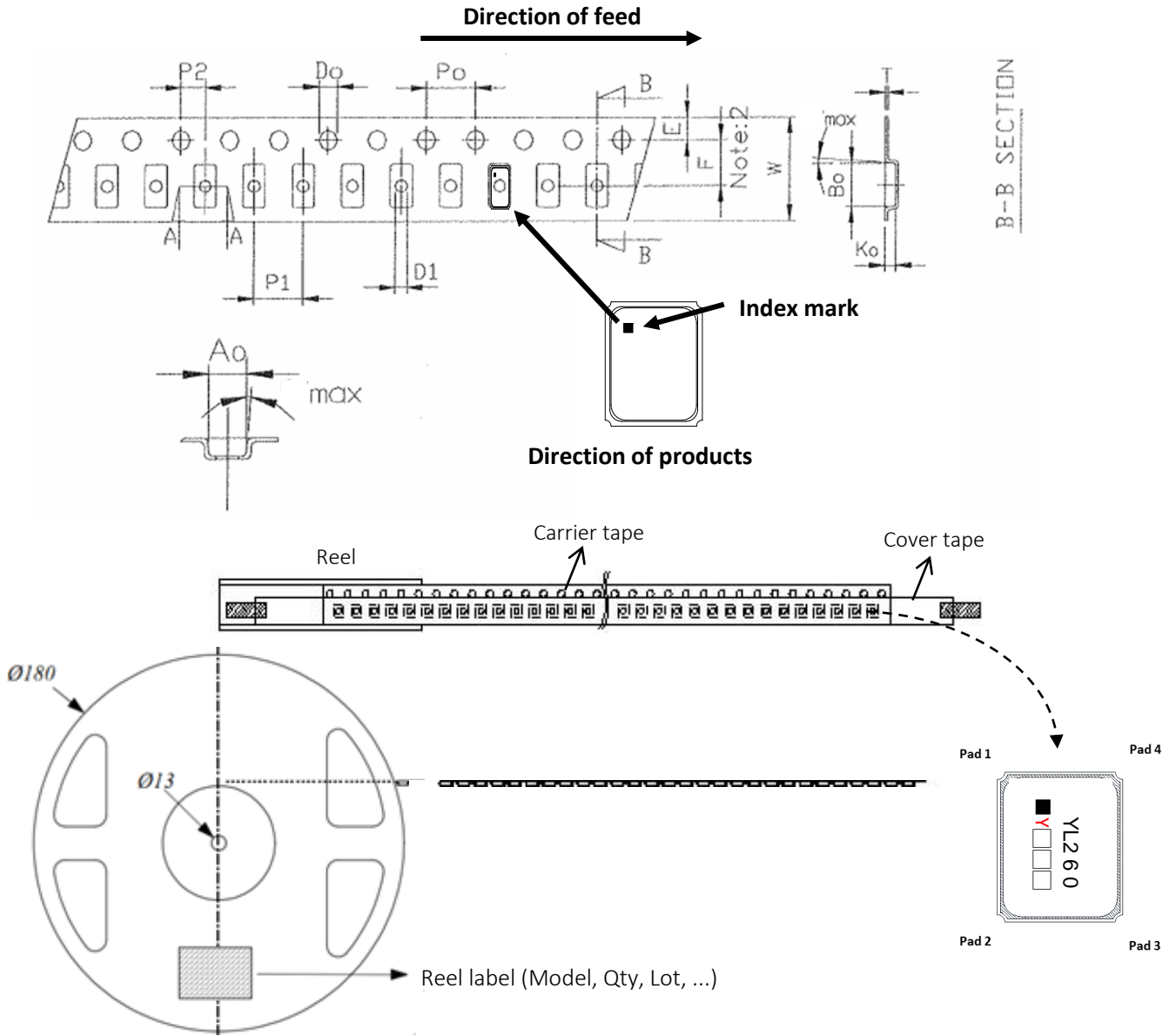

Package Type	Dimension (Unit : mm)						
2520 TSX (8mm)	A ₀	B ₀	K ₀	T	W	E	F
	2.25±0.1	2.70±0.1	1.45±0.1	0.25±0.05	8.00±0.3	1.75±0.2	3.50±0.1
	P1	P2	D1	D ₀	P ₀		
	4.00±0.1	2.00±0.1	1.00±0.1	1.55±0.05	4.00±0.1		

Standard Reel Quantity is 3000 pcs per reel.



The inspection standard of tape tension

Item		Defect	Method
Appearance	All	1. The tape is not coincidence 2. The bubble	Visual inspection
Tape tension	2520 - 8mm	Overstep 55±6g (49 to 61g)	Pull test



5. Taping and Packing (Cont.)

5.2 Packing standard

Out-going packing instruction

Reel packing	Inner packing	Carton
Name : Reel Standard : Diameter 18cm Material : Plastics Name : Anti-static shielding bag Standard : 205×250mm Material : APET/ CPP	Name : Bubble wrap Standard : 430×330×(t)20mm Material : HDPE Quantity : Max.15 reels	Name : Carton Standard : 400×400×(H)280mm Material : AB corrugated paper Quantity : 4 bags
		

The label information

Label	Label Drawing	Name of Article	Spec.	Label size	Printing
L1		条码标签 Bar Code Label	1.Customer P/N 2.Manufacturer P/N 3.Q'ty 4.Vendor Code 5.Lot No 6.Date Code 7.Manufacturer 8.Country of Origin	70×50mm	White
L2		条码标签 Bar Code Label	1.PO NO 2.Customer P/N 3.Manufacturer P/N 4.Q'ty 5.Vendor Code 6.Lot No 7.Date Code 8.Manufacturer 9.Country of Origin	100×75mm	White
L2		条码标签 Bar Code Label	1.Date Code 2.Q'ty	100×75mm	White

Remark: Specifications on the label is for default templates purpose and may change with different product.
 If any specified requirements for labels packaging is needed, please provide the instruction information.

6. Specification of the Environment-related Substances

#	Range	Max. concentration (ppm; mg/kg)	
	Banned Substances	Product	Packing
1	镉及镉化合物 Cadmium and cadmium compounds	100	100
2	铅及铅化合物 Lead and lead compounds	1000	100
3	汞及汞化合物 Mercury and mercury compounds	1000	100
4	六价铬化合物 Hexavalent-Chromium VI (Cr ⁺⁶)	1000	100
5	聚溴联苯 PBB Polybrominated biphenyls	1000	N/A
6	聚溴二苯醚 PBDE Polybrominated diphenyl ethers	1000	N/A
7	邻苯二甲酸二(2-乙基己基)酯 DEHP Di (2-ethylhexyl) phthalate	1000	N/A
8	邻苯二甲酸丁苄酯 BBP Butyl Benzyl Phthalate	1000	N/A
9	邻苯二甲酸二丁酯 DBP Dibutyl Phthalate	1000	N/A
10	邻苯二甲酸二异丁酯 DIBP Diisobutyl Phthalate	1000	N/A
11	氟(F)、氯(Cl)、溴(Br)、碘(I) Fluorine, Chlorine, Bromine, Iodine	900、900、900、900 注：Br + Cl < 1000	N/A
12	包装材料中重金属(汞、镉、六价铬、铅、PBB、PBDE)之总量 Heavy metals (mercury, cadmium, lead, Cr ⁺⁶ , PBB and PBDE) in packing materials	N/A	100 铅(Pb) + 镉(Cd) + 汞(Hg) + 六价铬(Cr+6) < 100ppm
13	高度关注物质 SVHC-Substances of Very High Concern	1000	N/A