

Product name TSX-3225 40.000000 MHz 9.0 +10.0-10.0

Product Number / Ordering code X1E0000210177xx

Please refer to the 5.Packing information about xx (last 2 digits)

Pb free / Complies with EU RoHS directive

Reference weight Typ. 17 mg

**1.Absolute maximum ratings**

Parameter	Symbol	Min.	Typ.	Max.	Unit	Conditions / Remarks
Storage temperature	T_stg	-40	-	+125	°C	Storage as single product
Operating temperature	T_use	-40	-	+105	°C	

**2.Specifications(characteristics)**

Parameter	Symbol	Min.	Typ.	Max.	Unit	Conditions / Remarks
Nominal frequency	f_nom	—	40.000000	—	MHz	Fundamental
Frequency tolerance	f_tol	-10	-	+10	x 10 <sup>-6</sup>	@+25°C
Frequency Stability over temperature	f_tem	-20	-	+20	x 10 <sup>-6</sup>	-40°C to +85°C
Operating temperature	T_use	-40	-	+85	°C	
Level of drive	DL	10	100	200	μW	
Load capacitance	CL	—	9	—	pF	
Motional resistance (ESR)	R1	-	-	40	Ω	
Motional capacitance	C1	-	4.41	-	fF	
Motional inductance	L1	-	3.59	-	mH	
Shunt capacitance	C0	-	1.31	-	pF	
Frequency aging	f_age	-2	—	+2	x10 <sup>-6</sup> /yea	@+25°C, First year

**3.External dimensions (Unit: mm)**

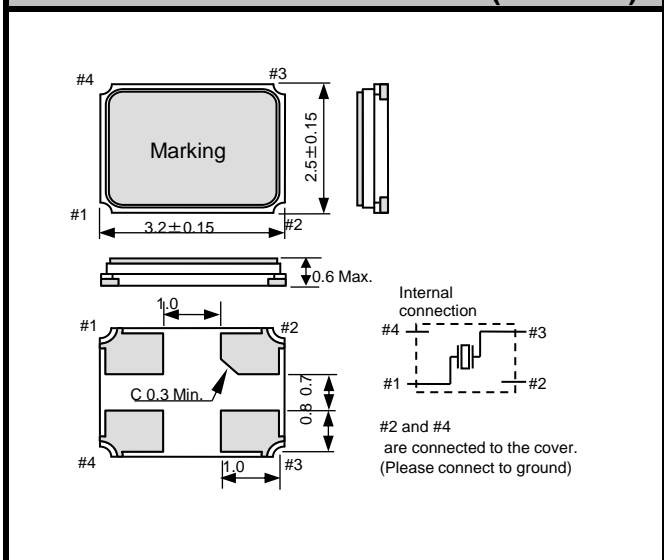

**4.Footprint(Recommended) (Unit: mm)**

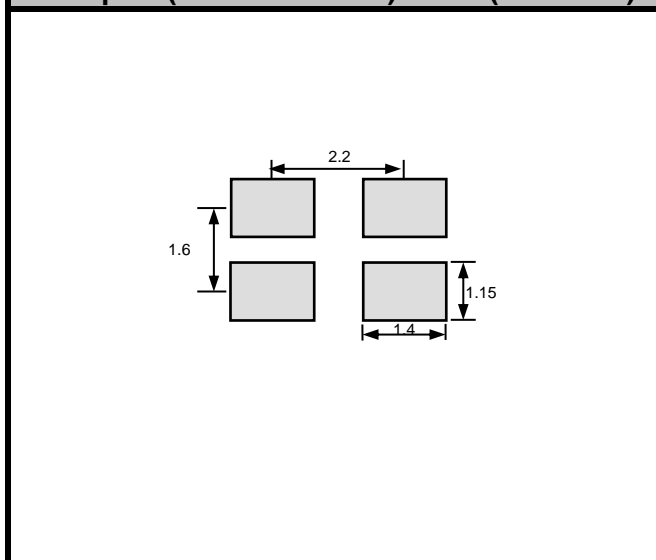

**5.Packing information**

[ 1 ] Product number last 2 digits code (xx) description The recommended code is "17"

X1E0000210177xx

Code	Condition	Code	Condition
01	Any Q'ty vinyl bag(Tape cut)	00	2000pcs / Reel
11	Any Q'ty / Reel	16	3000pcs / Reel
12	250pcs / Reel	17	4000pcs / Reel
14	1000pcs / Reel		

[ 2 ] Taping specification

Subject to EIA-481 & IEC-60286

(1) Tape dimensions TE0804L

Material of the Carrier Tape : PS

Material of the Top Tape : PET+PE

Unit: mm



(2) Reel dimensions

Center material : PS

Material of the Reel : PS

Unit: mm



V(mm)	W(mm)
9.0 $\pm$ 0.3	11.4 $\pm$ 1

