

MO1630

Ultra-Low Power, Ultra-Small 32.768 kHz or 16.384kHz Oscillator



Features

- <20 ppm initial tolerance
- <100 ppm stability over -40°C to +85°C
- Small SMD package: 2.0 x 1.2 mm (2012)^[1]
- SOT23-5 package option for industrial and Automotive applications
- Ultra-low power: 1.0 μA typ
- Vdd supply range: +1.5V to +3.63V
- Wide Operating temperature range options
- Internal filtering eliminates external Vdd bypass capacitors
- Pb-free, RoHS and REACH compliant

Applications

- Industrial timekeeping
- Industrial battery management
- Multi-drop 32 kHz clock distribution
- Bluetooth modules
- WiFi modules
- RTC Reference Clock



Note:

1. For the smallest 32 kHz XO in CSP (1.2mm²), consider the MO1532.

Table 1. Electrical Characteristics

Parameter	Symbol	Min.	Typ.	Max.	Unit	Condition
Frequency and Stability						
Output Frequency	F _{out}		32.768 16.384		kHz	
Frequency Stability						
Initial Tolerance ^[2]	F _{init}	–	–	20	ppm	T _A = +25°C, post reflow, V _{dd} : +1.5V – +3.63V.
Frequency Stability Over Temperature ^[3]	F _{stab}	–	–	75	ppm	T _A = -10°C to +70°C, V _{dd} : +1.5V – +3.63V.
		–	–	100		T _A = -40°C to +85°C, V _{dd} : +1.5V – +3.63V.
		–	–	150		T _A = -40°C to +105°C, V _{dd} : +1.5V – +3.63V.
25°C Aging		-1.0	–	+1.0	ppm	1st Year
Supply Voltage and Current Consumption						
Operating Supply Voltage	V _{dd}	+1.5	–	+3.63	V	T _A = over temperature
Operating Current	I _{dd}	–	+1.0	–	μA	T _A = +25°C, V _{dd} : +1.5V – +3.3V. No load
		–	–	+1.30		T _A = -10°C to +70°C, V _{dd} max: +3.63V. No load
		–	–	+1.40		T _A = -40°C to +85°C, V _{dd} max: +3.63V. No load
		–	–	+2.80		T _A = -40°C to +105°C, V _{dd} max: +3.63V. No load
Power-Supply Ramp	t _{Vdd_Ramp}	–	–	100	ms	Over temperature, 0 to 90% V _{dd}
Start-up Time at Power-up	T _{start}	–	180	300	ms	-40°C ≤ T _A ≤ +50°C, valid output
		–	–	450		-40°C ≤ T _A ≤ +85°C, valid output
		–	–	500 + 1period		T _A = -55°C and +105°C
Operating Temperature Range						
Commercial Temperature	T _{opn}	-10	–	+70	°C	Temp code "C" in part number ordering
Industrial Temperature		-40	–	+85		Temp code "I" in part number ordering
Extended Industrial Temperature		-40	–	+105		Temp code "E" in part number ordering
Extended Cold Industrial Temperature		-55	–	+85		Temp code "K" in part number ordering
Automotive Temperature Range		-55	–	+105		Contact KDS for Availability.
LVCMOS Output, T_A = Over Temperature, typical values are at T_A = +25°C						
Output Rise/Fall Time	t _r , t _f	–	100	200	ns	10-90%, 15 pF load, V _{dd} = +1.5V to +3.63V
Output Clock Duty Cycle	DC	48	–	52	%	
Output Voltage High	V _{OH}	90%	–	–	V	V _{dd} : +1.5V – +3.63V. I _{OH} = -10 μA, 15 pF
Output Voltage Low	V _{OL}	–	–	10%	V	V _{dd} : +1.5V – +3.63V. I _{OL} = +10 μA, 15 pF
Maximum Output Drive		–	–	50	pF	≥80% LVCMOS swing, T _A = over temperature, V _{dd} = +1.5V to +3.3V
Period Jitter	T _{jitt}	–	35	–	ns _{RMS}	Cycles = 10,000, T _A = +25°C

Notes:

2. Measured peak-to-peak. Tested with Agilent 53132A frequency counter. Due to the low operating frequency, the gate time must be ≥100 ms to ensure an accurate frequency measurement.
3. Measured peak-to-peak. Inclusive of Initial Tolerance at +25°C, and variations over operating temperature, rated power supply voltage and load.

Table 2. TPin Configuration

SMD Pin	SOT23-5 Pin	Symbol	I/O	Functionality
1	2,3	NC/GND	No Connect	Connect to GND or leave floating.
2	1	GND	Power Supply Ground	Connect to ground. All GND pins must be connected to power supply ground.
3	5	CLK Out	OUT	Oscillator clock output. When interfacing to an MCU's XTAL input, the CLK Out is typically connected to the receiving IC's X IN pin.
4	4	Vdd	Power Supply	Connect to power supply $+1.5V \leq Vdd \leq +3.63V$. Under normal operating conditions, Vdd does not require external bypass/decoupling capacitor(s). Internal power supply filtering will reject more than ± 150 mVpp with frequency components through 10 MHz.

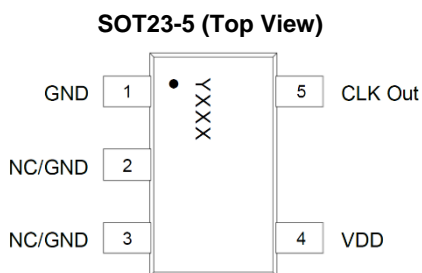

Figure 1. Pin Assignments

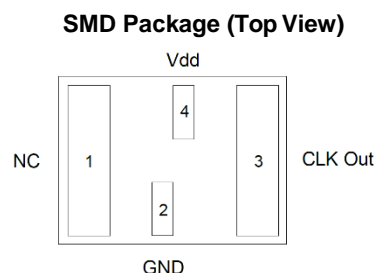

Figure 2. Pin Assignments

System Block Diagram

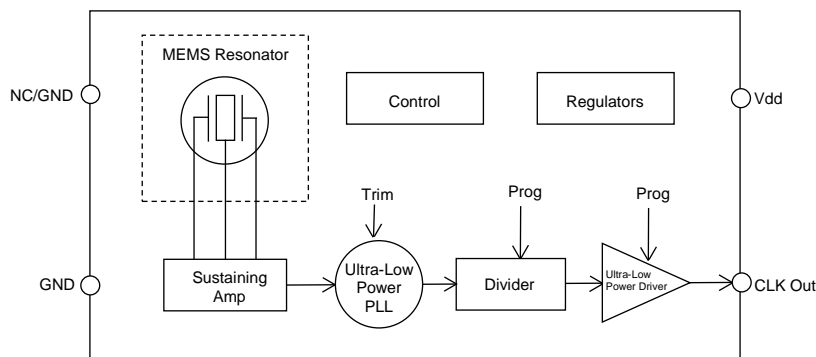

Figure 3. MO1630 Block Diagram

Absolute Maximum

Attempted operation outside the absolute maximum ratings may cause permanent damage to the part. Actual performance of the IC is only guaranteed within the operational specifications, not at absolute maximum ratings.

Parameter	Test Condition	Value	Unit
Continuous Power Supply Voltage Range (Vdd)		-0.5 to +3.63	V
Short Duration Maximum Power Supply Voltage (Vdd)	≤ 30 minutes, over -40°C to $+85^{\circ}\text{C}$	+4.0	V
Short Duration Maximum Operating Temperature Range	$Vdd = +1.5V - +3.63V, \leq 30$ mins	+125	$^{\circ}\text{C}$
Maximum Continuous Operation Temperature Extreme (meeting datasheet limits)	$T_A = -55^{\circ}\text{C}$, Continuous $Vdd = +1.8V - +3.3V \pm 10\%$	8	Hours
Human Body Model ESD Protection	HBM, JESD22-A114	+3000	V
Charge-Device Model (CDM) ESD Protection	JESD220C101	+750	V
Machine Model (MM) ESD Protection	$T_A = +25^{\circ}\text{C}$	+300	V
Latch-up Tolerance	JESD78 Compliant		
Mechanical Shock Resistance	Mil 883, Method 2002	10,000	g
Mechanical Vibration Resistance	Mil 883, Method 2007	70	g
2012 SMD Junction Temperature		+150	$^{\circ}\text{C}$
Storage Temperature		-65°C to $+150^{\circ}\text{C}$	

Description

The MO1630 is an ultra-small and ultra-low power 32.768 kHz oscillator optimized for battery-powered applications.

KDS's MEMS oscillators consist of MEMS resonators and a programmable analog circuit. Our MEMS resonators are built with unique MEMS process. A key manufacturing step is Epi-Seal during which the MEMS resonator is annealed with temperatures over +1000°C. Epi-Seal creates an extremely strong, clean, vacuum chamber that encapsulates the MEMS resonator and ensures the best performance and reliability. During Epi-Seal, a poly silicon cap is grown on top of the resonator cavity, which eliminates the need for additional cap wafers or other exotic packaging. As a result, KDS's MEMS resonator die can be used like any other semiconductor die. One unique result of KDS's MEMS process and Epi-Seal manufacturing processes is the capability to integrate KDS's MEMS die with a SOC, ASIC, microprocessor or analog die within a package to eliminate external timing components and provide a highly integrated, smaller, cheaper solution to the customer.

Frequency Stability

The MO1630 is factory calibrated (trimmed) to guarantee frequency stability to be less than 20 ppm at room temperature and very tight stability over temperature. Unlike quartz crystals that have a classic tuning fork parabola temperature curve with a +25°C turnover point, the MO1630 temperature coefficient is extremely flat across temperature.

When measuring the MO1630 output frequency with a frequency counter, it is important to make sure the counter's gate time is ≥ 100 ms. The slow frequency of a 32 kHz clock will give false readings with faster gate times.

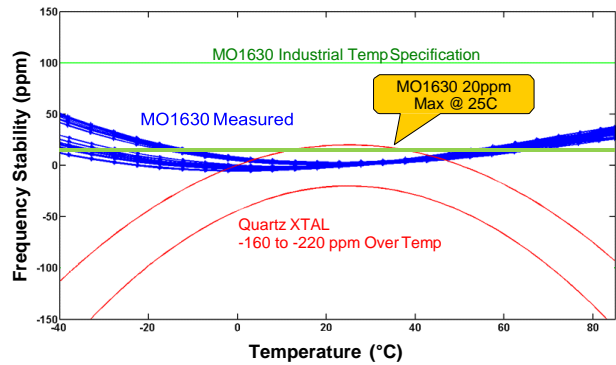

Figure 4. MEMS vs. Quartz

Power Supply Noise Immunity

The MO1630 is an ultra-small 32 kHz oscillator. In addition to eliminating external output load capacitors common with standard XTALs, this device includes special power supply filtering and thus, eliminates the need for an external Vdd bypass-decoupling capacitor. This feature further simplifies the design and keeps the footprint as small as possible. Internal power supply filtering is designed to reject AC-noise greater than ± 150 mVpp magnitude and beyond 10 MHz frequency component.

Power-up

The MO1630 starts-up to a valid output frequency within 300 ms (180 ms typ). To ensure the device starts-up within the specified limit, make sure the power-supply ramps-up in approximately 10 - 20 ms (to within 90% of Vdd).

Typical Operating Curves

($T_A = +25^\circ\text{C}$, $V_{dd} = +1.8\text{V}$, unless otherwise stated)

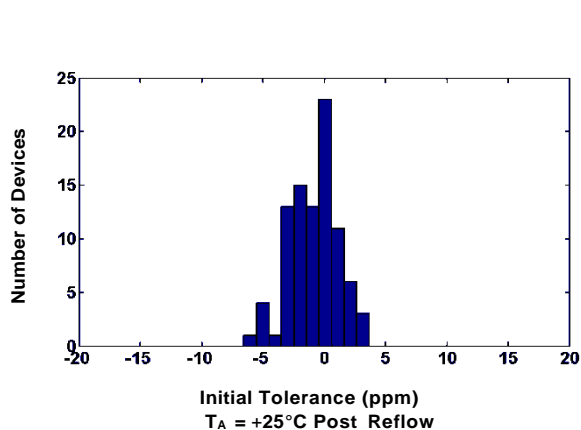

Figure 5. Initial Tolerance Histogram

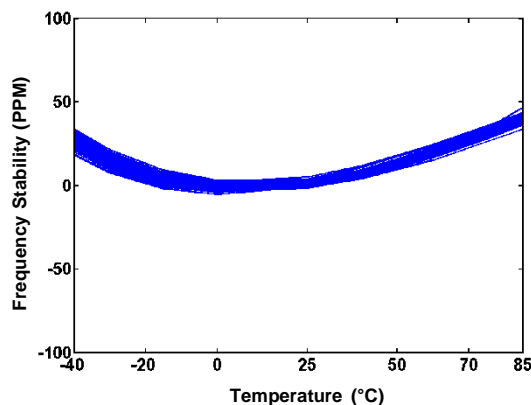

Figure 6. Frequency Stability Over Temperature

Supply Current Over Temperature (No Load)

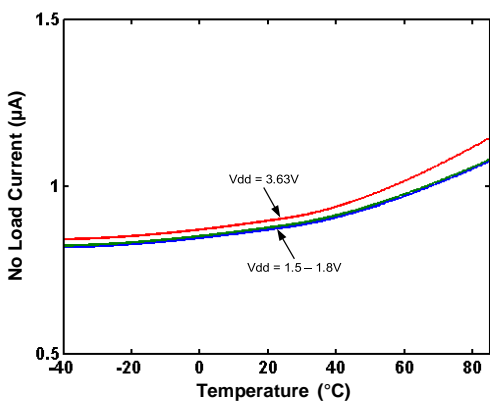

Figure 7. Supply Current Over Temperature (No load)

Start-up Time

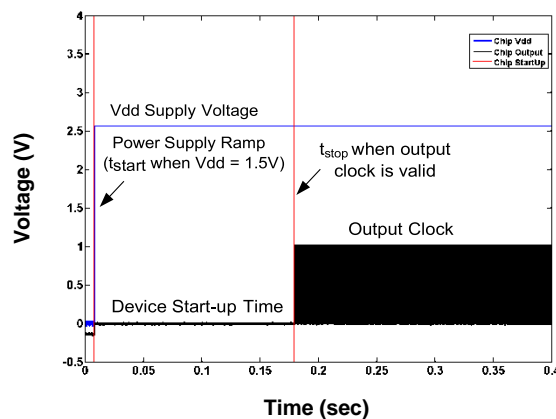

Figure 8. Start-up Time

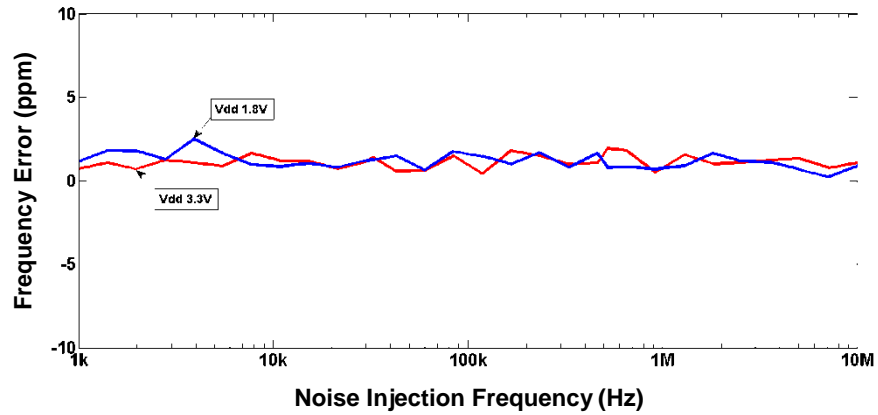

Figure 9. Power Supply Noise Rejection ($\pm 150\text{mV}$ Noise)

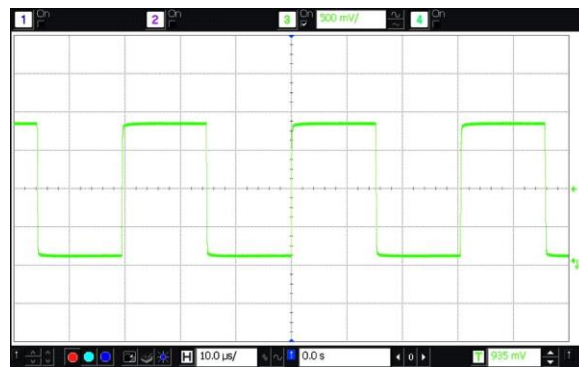

Figure 10. LVC MOS Output Waveform
(Vswing = +1.8V, MO 1630IJ4-DCCM-YY-032768)

Dimensions and Patterns

Package Size – Dimensions (Unit: mm)	Recommended Land Pattern (Unit: mm)
<p>2.0 x 1.2 mm SMD</p>	
<p>2.90 x 2.80 mm SOT23-5</p>	

Table 4. SOT23-5 Dimension Table

Symbol	Min.	Nom.	Max.
A	0.90	1.27	1.45
A1	0.00	0.07	0.15
A2	0.90	1.20	1.30
b	0.30	0.35	0.50
c	0.14	0.15	0.20
D	2.75	2.90	3.05
E	2.60	2.80	3.00
E1	1.45	1.60	1.75
L	0.30	0.38	0.55
L1	0.25 REF		
e	0.95 BSC.		
e1	1.90 BSC.		
α	0°	–	8°

Manufacturing Guidelines

- 1) No Ultrasonic Cleaning: Do not subject the MO1630 to an ultrasonic cleaning environment. Permanent damage or long term reliability issues to the MEMS structure may occur.
- 2) For Noisy, high EM environments, we recommend the following design guidelines:
 - Place oscillator as far away from EM noise sources as possible (e.g., high-voltage switching regulators, motor drive control).
 - Route noisy PCB traces, such as digital data lines or high di/dt power supply lines, away from the KDS oscillator.
 - Add a low ESR/ESL, 0.1 μ F to 1.0 μ F ceramic capacitor (X7R) to help filter high frequency noise on the Vdd power-supply line. Place it as close to the KDS oscillator Vdd pin as possible.
 - Place a solid GND plane underneath the KDS oscillator to shield the oscillator from noisy traces on the other board layers.
- 3) For additional manufacturing guidelines and marking/tape-reel instructions, contact KDS.

Ordering Information

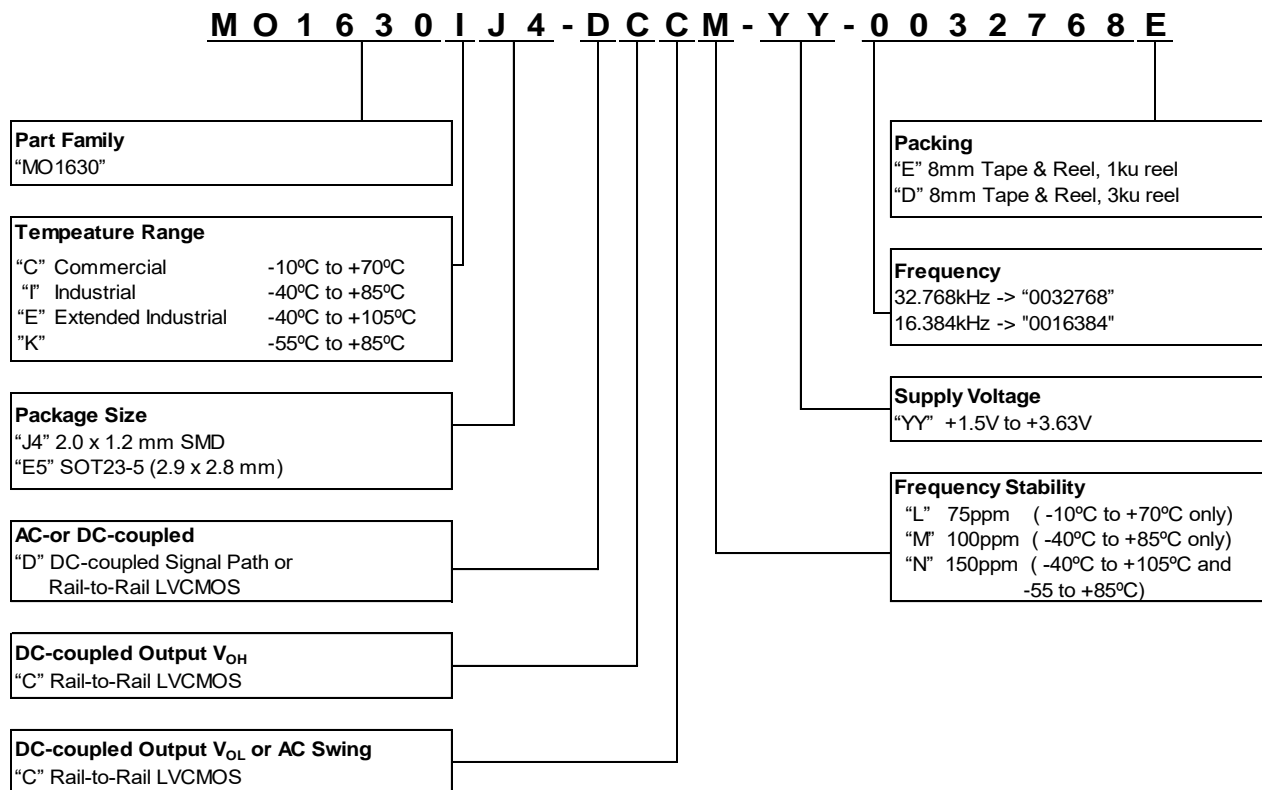

Table 5. Revision History

Version	Release Date	Change Summary
1.0	9/3/14	Rev 0.85 Preliminary to Rev 1.0 Production Release <ul style="list-style-type: none"> Updated start-up time specification Deleted SOT23 package option Added typical operating plots Added maximum output drive specification Added <i>Manufacturing Guidelines</i> section
1.1	9/3/14	<ul style="list-style-type: none"> Updated start-up time plot in <i>Typical Operating Curves</i> section Updated start-up time specification
1.2	11/25/14	<ul style="list-style-type: none"> Added additional design-in/mfg guidelines
1.3	02/09/2018	<ul style="list-style-type: none"> Added SOT23-5 package option Improved max supply current for commercial and industrial temp ranges Improved max start-up time at 85°C Updated start-up time temperature range conditions Updated Ordering information