

REAL TIME CLOCK MODULE (SPI)

For Automotive, Built-in 32.768 kHz DTCXO,
High Stability, +125 °C



Product Number (2,000 pcs / Reel)
RA4000CE YB A0 : X1B000491A00115
RA4000CE YB B8 : X1B000491A00915
RA4000CE YB C0 : X1B000491A01015
RA4000CE YB D0 : X1B000491A01115
RA4000CE YB E8 : X1B000491A01915

RA4000CE

- Built in frequency adjusted 32.768 kHz crystal unit and DTCXO
- Interface Type : 3 wire / 4 wire SPI-Bus
- Time stamp function : 2 time stamps from year to second
- Reset functions with a delay : Output a reset signal when a V_{DD} voltage drop status is detected.
- Interrupt output : Wake up every minute or every second
- Alarm interruption : Day, date, hour, minute, second
- Auto repeat wakeup timer interruption
- Self-monitoring interruption : Crystal oscillation stop, V_{DD} low
- AEC-Q100 compliant

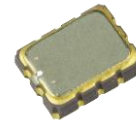

RA4000CE
(3.2 × 2.5 mm, t = 1.0 mm Max.)

Block diagram

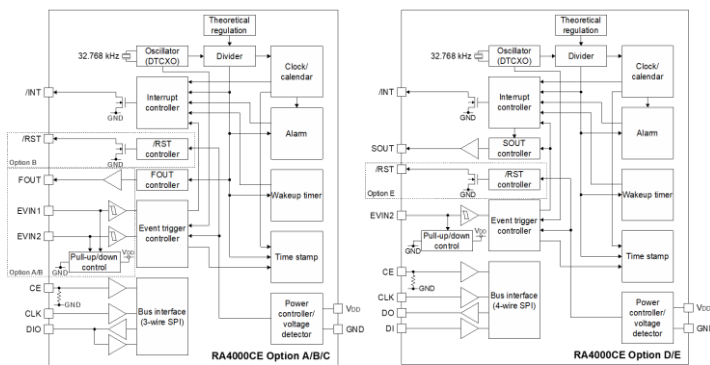

Overview

- Interface type
3 wire / 4 wire SPI-Bus
- High stability
± 5.0 × 10⁻⁶ / -40 °C to +85 °C (Monthly rate: ±13.2 seconds)
± 8.0 × 10⁻⁶ / +85 °C to +105 °C (Monthly rate: ±21 seconds)
± 50.0 × 10⁻⁶ / +105 °C to +125 °C (Monthly rate: ±132 seconds)
- Clock output function
Selectable from 32.768 kHz, 1024 Hz and 1 Hz outputs
- Wakeup timer function
Selectable from 976.56 μs to 32 years cycle
Can be used as a time integration meter
Can be used like a watchdog timer
- Time stamp function
Record data: 1/1024 seconds to 1 second, seconds, minutes, hours, days, months, years
Number of recordable events: 2 events
Trigger source: External event (EVIN) input, voltage drop/oscillation stop status detected, command input from the host
EVIN pin has function of chattering-cancel
- Reset function with a delay
Can output a reset signal when a V_{DD} voltage drop status is detected
- Status output (SOUT)
Can output the selected internal flag (interrupt flag, voltage drop detection flag) status.

Pin Function

Signal Name	I / O	Function
EVIN1, 2	Input	External event input pins Pull-up and pull-down is configurable by the registers
CE	Input	Slave select input pin A pull-down resistor (Typ. 300 kΩ) is included
CLK	Input	Serial clock input pin
DI	Input	Serial data input pin (4 wire)
DO	Output	Serial data Output pin (4 wire)
DIO	Input / Output	Serial data input/output pin (3 wire)
FOUT	Output	Frequency output pin (CMOS). 32.768 kHz (default), 1024 Hz or 1 Hz clock output is selectable. This pin can be switched to the wakeup timer interrupt output (CMOS)
/INT	Output	Interrupt output pin (N-ch. open drain). The wakeup timer, time update, alarm, and/or event detection interrupt signals can be selected to output from this pin. When two or more signals are selected, they are NORed before being output.
/RST	Output	Reset output pin (N-ch. open drain)
SOUT	Output	Status output pin
V _{DD}	-	Power-supply pin
GND	-	Ground pin

Terminal connection / External dimensions (Unit: mm)

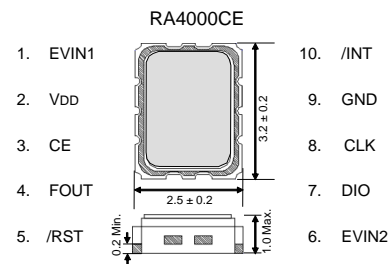

*The above diagram is the terminal layout for Option B.
For other options, please refer to the Pin Option section.

Specifications (characteristics)

* Refer to application manual for details

■ Electrical Characteristics

Item	Symbol	Conditions	Min.	Typ.	Max.	Unit		
Operating voltage	V _{DD}	-	1.6	3.0	5.5	V		
Temp. compensated Voltage	V _{TEM}	-	1.6	3.0	5.5	V		
Clock supply voltage	V _{CLK}	-	1.3	3.0	5.5	V		
Operating temperature	T _a	-	-40	+25	+125	°C		
Frequency tolerance	Δ f / f	YB T _a = -40 °C to +85 °C T _a = +85 °C to +105 °C T _a = +105 °C to +125 °C	±5.0			x 10 ⁻⁶		
			±8.0					
			±50.0					
Current consumption	I _{DD1}	/INT = Hi-Z, FOUT: Output OFF (Hi-Z), Temp. Compensation interval 2.0 s, CE = L	No /RST pin	V _{DD} = 5 V	-	0.35	1.8	μA
	I _{DD2}		With /RST pin	V _{DD} = 3 V	-	0.3	1.7	
	I _{DD11}			V _{DD} = 5 V	-	1.5	3.7	
	I _{DD12}			V _{DD} = 2 V	-	0.6	2.25	

■ 32.768 kHz-DTCXO Frequency temperature characteristics (Example)

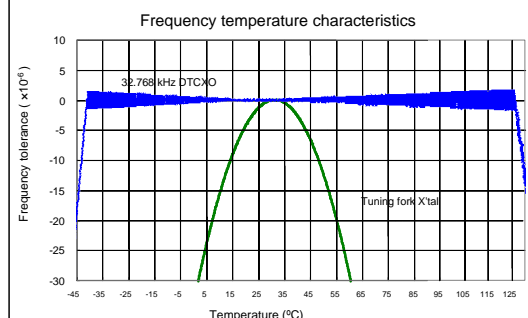



Pin Option

Pin No.	Pin name				
	Option A	Option B	Option C	Option D	Option E
	3 wire			4 wire	
1	EVIN1		N.C.	DI	
2	V _{DD}				
3	CE				
4	FOUT		/INT		
5	N.C.	/RST	N.C.		/RST
6	EVIN2		N.C.	EVIN2	
7	DIO			DO	
8	CLK				
9	GND				
10	/INT		N.C.	SOUT	

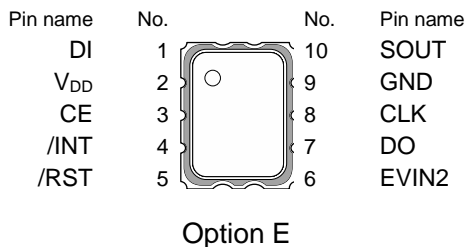
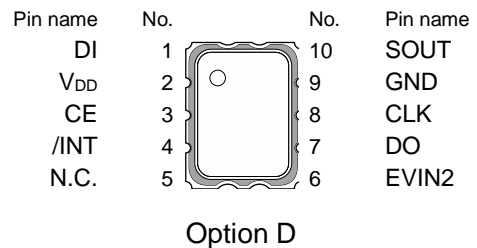
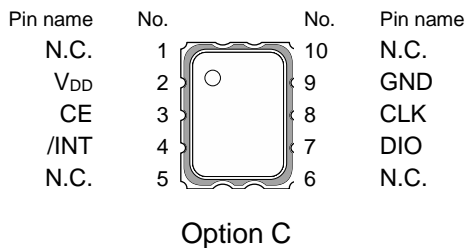
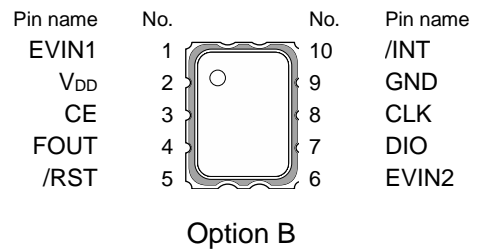
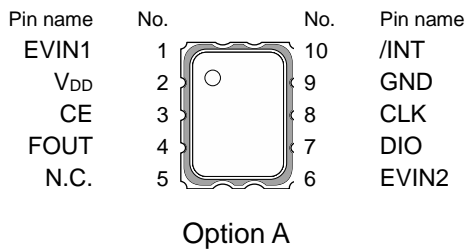

Product name

RA4000CE YB A 0
 ① ② ③④

- ① Model CE type package 3.2 x 2.5 x 1.0 mm
- ② Frequency tolerance
 YB: $\pm 5.0 \times 10^{-6}$ / -40 °C to +85 °C (Monthly rate: ± 13.2 seconds)
 $\pm 8.0 \times 10^{-6}$ / +85 °C to +105 °C (Monthly rate: ± 21 seconds)
 $\pm 50.0 \times 10^{-6}$ / +105 °C to +125 °C (Monthly rate: ± 132 seconds)
- ③ Pin Option
 A: Option A
 B: Option B
 C: Option C
 D: Option D
 E: Option E
- ④ Reset output function
 0: No /RST pin
 8: With /RST pin (V_{DD} drop detection voltage: +2.4 V Typ.)

PROMOTION OF ENVIRONMENTAL MANAGEMENT SYSTEM CONFORMING TO INTERNATIONAL STANDARDS

At Seiko Epson, all environmental initiatives operate under the Plan-Do-Check-Action (PDCA) cycle designed to achieve continuous improvements. The environmental management system (EMS) operates under the ISO 14001 environmental management standard.

All of our major manufacturing and non-manufacturing sites, in Japan and overseas, completed the acquisition of ISO 14001 certification.





ISO 14000 is an international standard for environmental management that was established by the International Standards Organization in 1996 against the background of growing concern regarding global warming, destruction of the ozone layer, and global deforestation.

WORKING FOR HIGH QUALITY

In order provide high quality and reliable products and services than meet customer needs, Seiko Epson made early efforts towards obtaining ISO9000 series certification and has acquired ISO9001 for all business establishments in Japan and abroad. We have also acquired IATF 16949 certification that is requested strongly by major automotive manufacturers as standard.

IATF 16949 is the international standard that added the sector-specific supplemental requirements for automotive industry based on ISO9001.

► Explanation of the mark that are using it for the catalog

	► Pb free.
	► Complies with EU RoHS directive. *About the products without the Pb-free mark. Contains Pb in products exempted by EU RoHS directive. (Contains Pb in sealing glass, high melting temperature type solder or other.)
	► Designed for automotive applications such as Car Multimedia, Body Electronics, Remote Keyless Entry etc.
	► Designed for automotive applications related to driving safety (Engine Control Unit, Air Bag, ESC etc).

NOTICE : PLEASE READ CAREFULLY BELOW BEFORE THE USE OF THIS DOCUMENT ©Seiko Epson Corporation 2020

- The content of this document is subject to change without notice. Before purchasing or using Epson products, please contact with sales representative of Seiko Epson Corporation ("Epson") for the latest information and be always sure to check the latest information published on Epson's official web sites and resources.
- This document may not be copied, reproduced, or used for any other purposes, in whole or in part, without Epson's prior consent.
- Information provided in this document including, but not limited to application circuits, programs and usage, is for reference purpose only. Epson makes no guarantees against any infringements or damages to any third parties' intellectual property rights or any other rights resulting from the information. This document does not grant you any licenses, any intellectual property rights or any other rights with respect to Epson products owned by Epson or any third parties.
- Using Epson products, you shall be responsible for safe design in your products; that is, your hardware, software, and/or systems shall be designed enough to prevent any critical harm or damages to life, health or property, even if any malfunction or failure might be caused by Epson products. In designing your products with Epson products, please be sure to check and comply with the latest information regarding Epson products (including, but not limited to this document, specifications, data sheets, manuals, and Epson's web site). Using technical contents such as product data, graphic and chart, and technical information, including programs, algorithms and application circuit examples under this document, you shall evaluate your products thoroughly both in stand-alone basis and within your overall systems. You shall be solely responsible for deciding whether to adopt/use Epson products with your products.
- Epson has prepared this document carefully to be accurate and dependable, but Epson does not guarantee that the information is always accurate and complete. Epson assumes no responsibility for any damages you incurred due to any misinformation in this document.
- No dismantling, analysis, reverse engineering, modification, alteration, adaptation, reproduction, etc., of Epson products is allowed.
- Epson products have been designed, developed and manufactured to be used in general electronic applications and specifically designated applications ("Anticipated Purpose"). Epson products are NOT intended for any use beyond the Anticipated Purpose that requires particular quality or extremely high reliability in order to refrain from causing any malfunction or failure leading to critical harm to life and health, serious property damage, or severe impact on society, including, but not limited to listed below ("Specific Purpose"). Therefore, you are strongly advised to use Epson products only for the Anticipated Purpose. Should you desire to purchase and use Epson products for Specific Purpose, Epson makes no warranty and disclaims with respect to Epson products, whether express or implied, including without limitation any implied warranty of merchantability or fitness for any Specific Purpose. Please be sure to contact our sales representative in advance, if you desire Epson products for Specific Purpose:
 - Space equipment (artificial satellites, rockets, etc.)/ Transportation vehicles and their control equipment (automobiles, aircraft, trains, ships, etc.) / Medical equipment/ Relay equipment to be placed on sea floor/ Power station control equipment / Disaster or crime prevention equipment/Traffic control equipment/ Financial equipment
 - Other applications requiring similar levels of reliability as the above
- Epson products listed in this document and our associated technologies shall not be used in any equipment or systems that laws and regulations in Japan or any other countries prohibit to manufacture, use or sell. Furthermore, Epson products and our associated technologies shall not be used for the purposes of military weapons development (e.g. mass destruction weapons), military use, or any other military applications. If exporting Epson products or our associated technologies, please be sure to comply with the Foreign Exchange and Foreign Trade Control Act in Japan, Export Administration Regulations in the U.S.A (EAR) and other export-related laws and regulations in Japan and any other countries and to follow their required procedures.
- Epson assumes no responsibility for any damages (whether direct or indirect) caused by or in relation with your non-compliance with the terms and conditions in this document or for any damages (whether direct or indirect) incurred by any third party that you give, transfer or assign Epson products.
- For more details or other concerns about this document, please contact our sales representative.
- Company names and product names listed in this document are trademarks or registered trademarks of their respective companies.